

**SALVIN**<sup>®</sup>  
Dental Specialties

*Everything For Your Implant  
Practice But The Implants<sup>®</sup>*

# 2024 INSTRUMENT CATALOG



***WE'RE IN BUSINESS  
TO IMPROVE YOUR  
SURGICAL OUTCOMES***



**Dr. Michael A. Pikos**  
Oral Surgeon  
Palm Harbor, FL

"Salvin Dental is an important resource for our practice and our course participants. They are great people to work with and won't let you make a mistake."



**Dr. Scott Froum**  
Periodontist  
New York, NY

"Not only does Salvin have a great product line, but their support of academics and advancement of dental technology is unparalleled."



**Dr. Hom-Lay Wang**  
Periodontist  
Ann Arbor, MI

"Salvin Dental has an excellent product line. Their commitment to quality and service has been a valuable resource for both my practice and my students."



**Dr. Mark Hunt**  
General Dentist  
Durham, NC

"Salvin's reliability is like a lifeline for my practice. They have a very professional, knowledgeable team. They're a great asset to my practice and to the students at our course."



**Dr. Michael Sonick**  
Periodontist  
Fairfield, CT

"There's a rare, consistent quality to Salvin products and service that's hard to find anywhere else. I use the Salvin catalog confidently for the implant courses and seminars I teach."



**Dr. Alvaro Ordonez**  
General Dentist  
Coral Gables, FL

"The team at Salvin Dental is always looking out for my best interest. Relationships like that are hard to find and impossible to replace."



**Dr. Dwayne Karateew**  
Periodontist/Prosthodontist  
Chicago, IL

"Every time I place an order with Salvin Dental my expectations for quality and service are exceeded. I consider them to be an invaluable partner in my practice and an asset to the profession."



**Dr. Randy Resnik**  
Prosthodontist  
Pittsburgh, PA

"The entire Salvin team is always willing to go above and beyond. I know I can count on them to get me exactly what I need, when I need it."



**Dr. James Wilson**  
Periodontist  
Tampa Bay, FL

"For over 20 years Salvin has been my most valuable corporate partner. They are customer satisfaction oriented and have a comprehensive portfolio. Their culture frowns on high-pressure salesmanship making them seem more like friends than sales reps."



**Dr. Scott Ganz**  
Prosthodontist  
Fort Lee, NJ

"As implant dentistry has evolved, so has Salvin Dental as a valuable resource to my practice. They are always well informed, and provide a personal touch that is very much appreciated by me and my staff."



**Dr. Edward Mills**  
General Dentist  
Atlanta, GA

"Every time you call Salvin you get a knowledgeable person who really wants to help your implant practice succeed. They have all the right products and great service – you're guaranteed to be satisfied."



**Dr. Mia Geisinger**  
Periodontist  
Birmingham, AL

"As an educator and a researcher, I am consistently impressed by Salvin Dental's support for residents and new practitioners. They have been an amazing resource for our practice and our students!"



**Dr. Brian Jackson**  
General Dentist  
Utica, NY

"I take pride in being able to say that I have been with Salvin Dental Specialties since its very beginning. Today, Salvin is a critical player on my team. I could not imagine performing implant surgery without Salvin."



**Dr. Jaime Lozada**  
Prosthodontist  
Loma Linda, CA

"The Salvin catalog is a snapshot of the very best products for the up-to-date implant practice. They always have the newest technology, and going the extra mile is the standard procedure at Salvin."



**Dr. Pat Allen**  
Periodontist  
Dallas, TX

"It's the quality people behind the quality products that sets Salvin Dental apart from the rest. Their knowledgeable, helpful, and friendly staff makes working with them a very pleasant experience."



**Dr. Christopher Richardson**  
Periodontist  
Richmond, VA

"Salvin Dental Specialties is so much more than a dental supply company. I consider Salvin and their team members to be an essential and collaborative partner in the care I provide my patients."



**Dr. Russ Baer**  
General Dentist  
Chicago, IL

"There are three things you need in Implant Dentistry: a well trained dentist, a good implant system, and your Salvin catalog. Salvin's products and customer support are an irreplaceable part of my implant practice."



**Dr. Rick Ferguson**  
General Dentist  
Pembroke Pines, FL

"Dealing with Salvin is a first-class experience. They have a reputation for always putting their customers first. They provide great service, value, and expertise to my practice and the students at our course."



**Dr. Tim Kosinski**  
General Dentist  
Bingham Farms, MI

"Working with the Salvin team for the past 30 years, I know that I can count on them for top of the line products and world class service. They are a valuable resource for my practice."



**Dr. Gordon Christensen**  
Prosthodontist  
Provo, UT

"I consider Salvin Dental to be a premium company in providing implant accessory supplies. The Salvin catalog is not only a resource for my practice, but also for the doctors who attend our courses."



**Dr. Jennifer Hirsch Doobrow**  
Periodontist  
Cullman, AL

"Loyalty, integrity, and excellence are what Salvin Dental embodies. Their commitment to impeccable service and outstanding quality is why they are a leader in the dental implant community."



**Dr. Michael Cohen**  
Periodontist  
Seattle, WA

"Salvin has a proven history of delivering what they promise, with all the ingredients necessary for a strong successful working relationship: Reliability, Knowledge and Integrity. You can't beat that combination!"



**Dr. Natalie Wong**  
Prosthodontist  
Toronto, Ontario, Canada

"Delivering excellent quality instrumentation with great service is what you can expect from Salvin. Professional, knowledgeable, and courteous, I consider them an integral part of my dental implant team."



**Dr. Robert Levine**  
Periodontist  
Philadelphia, PA

"Working with Salvin is like working with family. You get service, great products and ability to talk directly to staff who are incredibly helpful, knowledgeable & personable. I highly recommend Salvin and their quality products."



**Dr. Burt Melton**  
Prosthodontist  
Albuquerque, NM

"Salvin Dental has all the things you need for a day-to-day implant practice as well as all the special things you need from time to time. Salvin's products are always available for you when you need them in a hurry."



**Dr. Bach Le**  
Oral Surgeon  
Whittier, CA

"Salvin Dental has one of the most professional sales teams in the dental industry. They know that my time is valuable and always deliver more than they promise."



**Dr. Lee Silverstein**  
Periodontist  
Atlanta, GA

"When Salvin says everything for the implant practice but the implants, they mean it! Salvin is our prime resource for expertise and incredible service. They are a doctor's true friend in our industry."



**Dr. Joseph Cristoforo**  
Periodontist  
Madison, WI

"Knowledge. Service. Commitment. Salvin Consistently provides vast product knowledge, unparalleled service, and commitment to enhancing the clinical experience for both the provider and patient."



**Dr. Todd Engel**  
General Dentist  
Charlotte, NC

"Salvin Dental consistently delivers great products and excellent service. They have become an important resource for my practice."



**Dr. Peter Nordland**  
Periodontist  
La Jolla, CA

"The best aspect of Salvin Dental is the personal attention and knowledge that all of the staff members have whenever I call. I am always greeted with a kind, courteous, knowledgeable representative."



**Dr. John Giblin**  
Dental Surgeon  
Sydney, Australia

"Integrity, teamwork and service are what Salvin is about. Though they're half a world away, they always come through. Great friends who provide a masterful implant product line – a hallmark in the industry."



**Dr. Carlos Rubio**  
General Dentist  
Algodones, Mexico

"Salvin has been a major part in my professional growth as a dentist and a teacher. I have always been able to count on them to have the best quality material, as well as the service. Thanks Salvin for being there along the way."



**Dr. Richard Rasmussen**  
Periodontist  
Tampa, FL

"Salvin has a great team with one thing in mind...To make my practice and me their first priority, every time I call. I know that when I call Salvin, I've called the right place."



**Dr. Sayward E. Duggan**  
Periodontist  
Yorktown, VA

"Salvin consistently continues to set the bar high in the dental industry with excellent products, competitive prices, and above all superior client services. Thank you Salvin for your loyal professional support."



**Dr. Tyler Borg**  
Periodontist  
Northglenn, CO

"The team at Salvin Dental offers consistent support, continued product innovation, and top notch customer service. All in the pursuit of the ideal doctor and patient experience alike."



**Dr. Robert Heller**  
Prosthodontist  
Lewis Center, OH

"I confidently recommend Salvin Dental to our Midwest Institute students. Their knowledge and helpfulness make them a pleasure to do business with."



**Dr. George Duello**  
Periodontist  
St. Louis, MO

"These guys are more than just suppliers to my practice. Salvin Dental's team are proven consultants who help us every time we call. These professionals really know implant dentistry."



**Dr. Craig M. Misch**  
Oral Surgeon/Prosthodontist  
Sarasota, FL

"Salvin has a thorough product selection with great personalized customer service. I keep going back to Salvin for whatever I need for my implant practice and highly recommend them to my colleagues."



**Dr. George Kotsakis**  
Periodontist  
Hoboken, NJ

"It's always a pleasure to work with Salvin Dental because it's always a partnership rather than a business transaction. They genuinely care and always deliver. I would highly recommend Salvin."



**Dr. Jack Krauser**  
Periodontist  
Boca Raton, FL

"The Salvin catalog is perhaps the most valuable tool in implant dentistry. Their unique products and excellent service are a tremendous resource for my private practice and for our students at the school."



**Dr. Jason Stoner**  
Periodontist  
Dublin, OH

"Every time I call Salvin, I can count on speaking with a knowledgeable person with the answers I need. They know that my time is valuable and always deliver what they promise."



**Dr. Adam S. Foleck**  
General Dentist  
Norfolk, VA

"Salvin has provided expertise and experience necessary to take my implant practice to the next level. They do everything they can to ensure my success. Salvin helps me equip my offices to offer the highest level of treatment to my patients."



## NON-GLARE FEATHERWEIGHT MICROSURGERY INSTRUMENTS

Salvin Non-Glare Featherweight  
Microsurgery Instruments . . . . . 4-5

## ZYGOMATIC INSTRUMENTS

ZAGA Zygomatic Surgical Instruments . 6

## SALVIN IMPLANT RESCUE KIT

Failed Implant & Broken Abutment Screw  
Rescue Kit . . . . . 7

## CENTRIFUGES

Variable Speed Centrifuge . . . . . 8  
BIO-PRF Centrifuge . . . . . 9  
Blood Collection . . . . . 10

## IMPLANT STABILITY MONITOR

Penguin RFA Implant Stability Monitor 11

## MEMBRANE FIXATION

Membrane Tack Kits . . . . . 12-13  
Membrane Instruments . . . . . 14-15  
Titanium Mesh . . . . . 15

## TENTING & FIXATION SCREWS

Tenting Screw Kit . . . . . 16  
Fixations Screw Kit . . . . . 17

## MONITORS, DEFIB & O/R SAFETY

Vital Sign Monitors & Defibrillator . 18-22  
O/R Safety . . . . . 23-25

## BLEEDING CONTROL

OraFOAM™ Hemostatic Sponges . . . 26  
BloodSTOP® Hemostatic Gauze . . . . 26  
Hemostats . . . . . 26  
Bone Wax . . . . . 26  
HemCon® Dental DressingPro . . . . . 27  
Portable Electrocautery . . . . . 27

## SUTURES & WOUND CLOSING

Wound Closure . . . . . 28  
Sutures . . . . . 29-33

## INFECTION CONTROL / PPE

Sterile Drapes, Gowns & Covers . . . 34-39  
Scrub Brushes & O/R Prep . . . . . 40  
Instrument Care & Cassettes . . . . . 41-43  
Surgical Gloves . . . . . 44-45

## PIEZO ULTRASONIC SURGERY

Piezotome Ultrasonic Surgery Units 46-47  
Piezotome Tips & Procedure Kits . . 48-49

## MOTORS, HANDPIECES & DRILLS

Implant Handpieces . . . . . 50  
Implant Motors . . . . . 51  
Bone Saws . . . . . 52  
Irrigation Tubing . . . . . 53  
Drill Stops . . . . . 54  
Drills, Burs, Trephines & Bur Blocks 55-61  
Rear-Exhaust High Speed Handpiece . 62

## IMPLANT CLEANING

RotoBrush-Titanium® Brushes . . . . . 63  
Peri-Implantitis Bur Kit . . . . . 63

## PERI-IMPLANT MANAGEMENT INSTRUMENTS

Impla-Safe™ Peri-Implant  
Management Instruments . . . . . 64-65

## AUTO EXTRACTION & OSTEOTOME

AutoTome®-Extract  
Automatic Extraction Kit . . . . . 66  
AutoTome®  
Automatic Osteotome Kit . . . . . 67

## SURGICAL INSTRUMENTS

Atraumatic Extraction . . . . . 68-85  
Bone Curettes . . . . . 86  
Bone Grafting . . . . . 87-95  
Sinus Lifts . . . . . 96-102  
Mallets & Chisels . . . . . 103  
Rongeurs . . . . . 104-105  
Bone Spreading . . . . . 106-107  
Ridge Splitting . . . . . 108-109  
Micro Surgery & Tunneling . . . . . 110-117  
Periosteal Elevators . . . . . 118-120  
Retractors . . . . . 121-125  
Needle Holders . . . . . 126-129  
Scissors . . . . . 130-132  
Perio Knives & Surgical Files . . . . . 133  
Perio Curettes & Bone Files . . . . . 134  
Aspirating Anesthetic Syringes . . . . 135  
Tissue Forceps . . . . . 136-139  
Scalpels . . . . . 140-141  
Tissue Punches & Nippers . . . . . 142-143

## SUCTION, IRRIGATION

Suction & Irrigation . . . . . 144-149

## O/R FURNITURE

Implant/Surgical Cart . . . . . 150  
Surgical Tables . . . . . 151  
Sedation Chair Pad . . . . . 151  
Mayo & IV Stands . . . . . 152  
Table Covers & Mayo Stand Covers . 152

## HEADLAMPS

Enlighten-Pro3™ LED Headlamp . . . 153

## CASE PRESENTATION

Implant & Course Models . . . . . 154-159  
Case Presentation Book . . . . . 159

## DIAGNOSTICS

Spotter Smart Implant Detector . . . . 160  
Probes, Calipers & Drill Guides . . 161-164  
Mirrors & Contrasters . . . . . 165-166

## RESTORATIVE & HYGIENE

Improv Implant Cement . . . . . 167  
Crown Removers . . . . . 168-169  
Abutment Holders . . . . . 170  
Implant Hygiene . . . . . 170-171  
Torque Wrenches & Drivers . . . . . 172-175

*Complete Index On Pages 176-177*

**Trademarks:** "Salvin®", "Salvin Dental Specialties® Logo", "Everything For Your Implant Practice But The Implants®", "Salvin Regenerative®", AccessTorq®, AtraLux®, AutoTome®, BariOpaque®, CytoSurg®, EasyReach®, PDL-Evator®, Rapid Roll®, RotoBrush-Titanium®, Salvin AutoTorq®, Salvin Power Point®, SalvinTorq®, and SurgiPoint® are registered U.S. and international trademarks of Salvin Dental Specialties, Inc.

Enlighten-Pro3™ LED System, Salvin OraFOAM™, Salvin Black Kryptonite™, and Salvin Mesh-Ti™ are trademarks of Salvin Dental Specialties, Inc. Other product brand names may be trademarks or registered trademarks of their respective owners and are mentioned for reference purposes only.



# SALVIN<sup>®</sup> Dental Specialties

# SALVIN<sup>®</sup> Regenerative

Everything For Your Implant Practice But The Implants<sup>®</sup>

## 2024 INSTRUMENT CATALOG

PLUS EQUIPMENT, SUTURES, & INFECTION CONTROL

*We're in business to make your lives easier and improve your surgical outcomes.*

*Call us, we'll take great care of you!*

**—Bob Salvin**

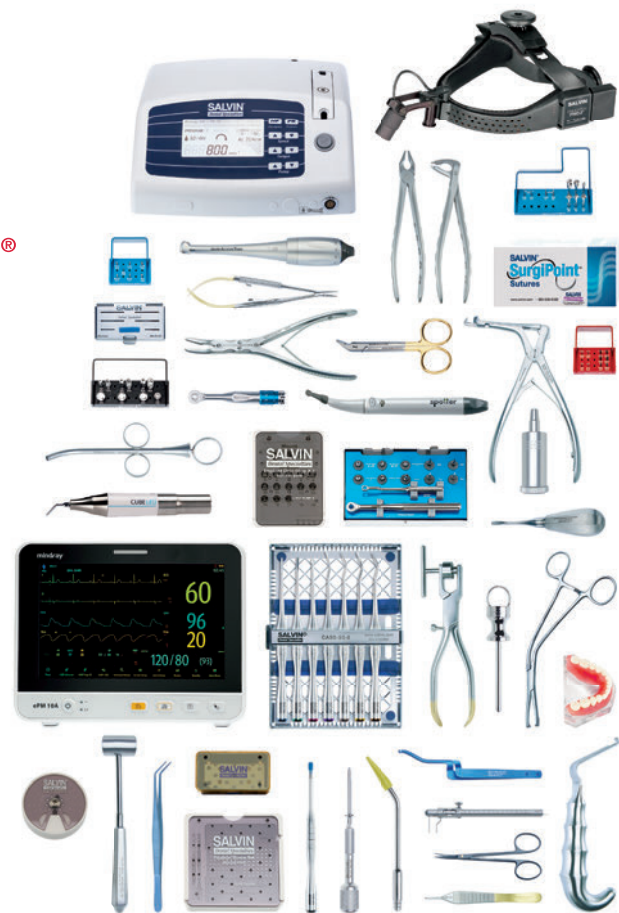

*Please See Our 2024 Regenerative Catalog For Bone Grafting Materials, Membranes, Amnion And Plugs.*

**800-535-6566 [Toll Free U.S. & Canada] • [www.salvin.com](http://www.salvin.com)**



Salvin Dental Specialties, Inc.  
3450 Latrobe Drive  
Charlotte, NC 28211 USA  
Ph: 704-442-5400 Fax: 704-442-5424  
Email: [orders@salvin.com](mailto:orders@salvin.com)  
Hours: M-Th: 8:30-7:00 F: 8:30-6:00  
(U.S. Eastern Standard Time)  
Quality Management System  
ISO 13485:2016 Certified

**See It Demonstrated!**  
Look For This Icon Throughout  
Our Catalog



**Sustainable Forest Initiative**



By supporting the SFI program, Salvin is helping to strengthen forest practices in North America and promote responsible sourcing globally.

### SALVIN INSTRUMENT LIFETIME WARRANTY

Salvin Branded Instruments are guaranteed to be free from defects in workmanship and material.

Any Salvin instrument which proves defective in workmanship or material will either be repaired or replaced at our discretion, without charge.

Warranty does not cover routine maintenance, re-tipping of carbide instruments or sharpening of scissors. Individual manufacturer warranties apply to products other than instruments.

Terms Of Sale: Payment terms are Visa, MasterCard, Discover or American Express. Prices in catalog are in U.S. funds and are subject to change due to unforeseen circumstances. Sales and Taxes, if applicable, are customer's responsibility. Foreign Orders: Foreign orders may be called in to 704-442-5400, faxed to 704-442-5424, or placed online at [www.salvin.com](http://www.salvin.com). Duties and import taxes, if any, are customer's responsibility. Hospital/School Orders: Institutional orders should be emailed to [orders@salvin.com](mailto:orders@salvin.com), faxed to 704-442-5424 or mailed to our office. Terms for hospital/school orders are net 30 with 1.5% per month late fee charged on past due accounts. Customers are responsible for legal and collection fees if required. Students may purchase by Visa, MasterCard, Discover or American Express.

**Salvin Non-Glare Featherweight Microsurgery Instruments**

*Custom Designed For Periodontal Microsurgery*

**NEW!**

- ▶ Light & Long
- ▶ Smooth Tips
- ▶ Rounded Handles
- ▶ Non-Locking
- ▶ Black Non-Glare Coating



"The Salvin microsurgical instruments exhibit a semicircular grip to enhance handling and haptic feedback; these instruments are light in weight to prevent muscle fatigue and have been designed without locking mechanisms to prevent undesirable traumatic instrument manipulation. The dark surface coating minimizes glaring when working under coaxial illumination. Once you use these finely crafted instruments it will be hard to work with any other set!"

**Dr. Diego Velasquez**  
Periodontist, Fenton, MI



"The Salvin microsurgery set combines the features needed in high quality surgical instrumentation. The non-reflective black coating effectively eliminates glare during surgeries, allowing for better visibility and precision. The lightweight design enhances our tactile control, and the smooth tips are conducive for manipulation of micro sutures. Salvin listened to what we needed and delivered!"

**Dr. Irene Marron-Tarrazzi**  
Periodontist, Miami, FL



"When performing perio plastic surgery under magnification and illumination, using specialized instrumentation is critical to my success. The Salvin microsurgery instruments check all of the requirements I need: Light, long, non-reflective, rounded handles and manufactured with the highest quality. This is exactly what I use in my practice."

**Dr. John Russo**  
Periodontist, Sarasota, FL



**Non-Glare Micro Tunneling - 1.2mm**

#MICRO-BLK-TUNNEL-1.2  
..... 103.80 EACH

**Non-Glare Micro Tunneling - 2.0mm**

#MICRO-BLK-TUNNEL-2.0  
..... 103.80 EACH

**Non-Glare Micro Tunneling - 2.8mm**

#MICRO-BLK-TUNNEL-2.8  
..... 103.80 EACH

Double-Ended Micro Tunnel Elevators Help Reflect & Elevate Tissue From Recipient Site In Precise Micro Flaps



**Non-Glare Lucas 85 Bone Curette**

Sharp Tips Efficiently Debride Sockets  
#LUCAS-85-BLK  
..... 89.00 EACH



**Non-Glare Prichard Elevator**

Double-Ended Micro Tunnel Elevators Help Reflect & Elevate Tissue From Recipient Site In Precise Micro Flaps  
#PRICHARD-BLK  
..... 84.40 EACH



**Non-Glare Perio Probe**

#PERIO-PROBE-BLK  
..... 99.00 EACH



**Non-Glare Papilla Elevator**

- Double-Ended Elevator
- Rounded Tip For Blunt Tissue Dissection

#PAPILLA-ELEV-BLK  
..... 99.00 EACH

**SPECIAL**

**Salvin Non-Glare Featherweight Microsurgery Set**

**NEW!**



**Includes:**

- Non-Glare Micro Tunneling - 2.0mm
  - Non-Glare Micro Tunneling - 2.8mm
  - Non-Glare Tissue Forcep - Curved OR
  - Non-Glare Tissue Forcep - Straight
  - Non-Glare Castroviejo
  - Non-Glare Micro Needle Holder - Curved
  - Non-Glare Micro Scissor - Curved
  - Non-Glare Lucas 85 Bone Curette
  - Non-Glare Prichard Elevator
  - Non-Glare Perio Probe
  - Non-Glare Papilla Elevator
  - Non-Glare Micro Blade Handle
  - Non-Glare Micro Mouth Mirror - 5mm
  - Non-Glare Mirror Handle
  - Plus **FREE** Instrument Cassette
- #NON-GLARE-MICRO-KIT**  
.....**.2390.00 SET**



**Non-Glare Castroviejo  
Micro Needle Holder -  
Curved**

- Light (<20 grams)  
And Long (18cm)  
For Easy Handling Of  
Micro Sutures
  - Smooth Tips Grasp  
Delicate Sutures, While  
The Rounded Handles  
Allow For Precise Control
- #MICRO-BLK-CASTRO-CUR**  
..... **509.00 EACH**



**Non-Glare  
Micro Scissor - Curved**

- Sharp, Slightly Curved,  
Long Scissors For Fine  
Resections Of Soft Tissues &  
Trimming Of Mucosal Grafts
- #MICRO-BLK-SCISS-CUR**  
..... **459.00 EACH**



**Non-Glare  
Mirror Handle**

- #MIRROR-HNDL-BLK**  
..... **65.00 EACH**



**Non-Glare  
Micro Mouth Mirror - 5mm**

- #MICRO-MIRR-5-BLK**  
..... **145.00 EACH**



**Non-Glare  
Micro Mouth Mirror  
- 3x6mm**

- #MICRO-MIRR-3X6-BLK**  
..... **145.00 EACH**



**Non-Glare  
Tissue Forcep -  
Curved**

- #MICRO-BLK-FORCEP-CUR**  
..... **459.00 EACH**

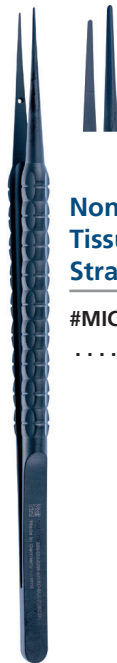

**Non-Glare  
Tissue Forcep -  
Straight**

- #MICRO-BLK-FORCEP-STR**  
..... **459.00 EACH**



**Non-Glare  
Suture Pliers**

- #MICRO-BLK-SUTURE-PLIER**  
..... **419.00 EACH**



**Non-Glare  
Micro Blade Handle**

- Fits Micro "Beaver-Type"  
Scalpel Blades
  - Collet Locks Blade In Place
- #MICRO-BLK-BLADE-HNDL**  
..... **135.00 EACH**



ZAGA Zygomatic Surgical Instruments

Designed By Dr. Carlos Aparicio – Creator Of The ZAGA Method

**NEW!**



**Salvin ZAGA 1 - Zygoma Dissector**

Detaches The Periosteum Beyond The Angle Formed By Temporal & Frontal Anatomy Of The Zygoma To Prepare For The Anchorage Of The Retractor

#ZAGA-1  
..... 129.00 EACH

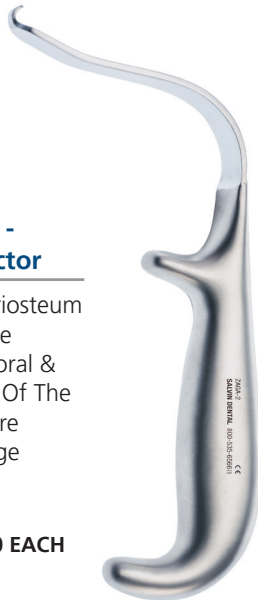

**Salvin ZAGA 2 - Zygoma Retractor**

- Increases Field Of Vision
- Directs The Drilling
- Prevents Perforation Of The Orbit
- Protects Soft Tissue While Drilling Superior Cortex

#ZAGA-2  
..... 204.00 EACH



“It is my pleasure to share this great set of instruments designed to sequentially facilitate the placement of zygomatic implants following the ZAGA philosophy.”  
**Dr. Carlos Aparicio**  
Periodontist, Barcelona, Spain



**Salvin ZAGA 3 - Maxilla Dissector**

Detaches The Periosteum From Posterior Part Of The Maxillary Wall & Detaches The Floor Of The Nose

#ZAGA-3  
..... 129.00 EACH



**Salvin ZAGA 4 - Posterior Dissector**

Finishes Detachment Of The Periosteum In More Posterior Superior Sectors

#ZAGA-4  
..... 129.00 EACH

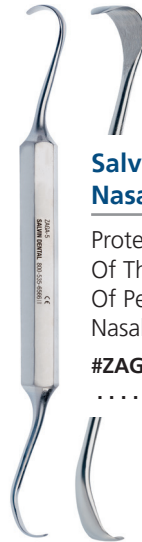

**Salvin ZAGA 5 - Nasal Protector**

Protects The Mucosa Of The Nose In Case Of Perforation Of The Nasal Floor

#ZAGA-5  
..... 129.00 EACH



**NEW!**

**Zygomatic Trough Bur**

- 2.3mm Pear Shape
- Fits Straight Handpieces
- 44mm Long

#MEIS-HM77MF-023-HP  
INDIVIDUALLY . . 28.45 EACH  
10 OR MORE . . . 26.95 EACH

**SPECIAL**

**Salvin ZAGA Instrument Set**

Includes:

- Zygoma Dissector
- Zygoma Retractor
- Maxilla Dissector
- Posterior Dissector
- Nasal Protector
- Plus **FREE** Salvin 10" x 6" Deep Instrument Cassette

#ZAGA-INSTR-KIT  
..... 716.00 SET



**NEW!**

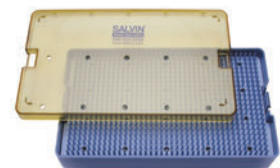

**Remove Failed Implants Or  
Broken Abutment Screws**



**SPECIAL**

**Implant Rescue Kit**

#IMPLANT-RESCUE-KIT ..... **1765.00 KIT**

**SPECIAL**

**Narrow Implant Broken Screw Kit**

For Broken Screw Removal On Small Diameter & Bone Level Implants

#IMPLANT-RESCUE-NARROW ..... **825.00 KIT**

**Broken Abutment Screw Removal**

- Helps To Remove Broken Screws Without Damaging The Implant
- Includes Centering Guides To Fit Most Implant Systems



Place Guide On Implant & Hold With Stabilizing Handle.  
Set Motor To **REVERSE** At 1,000-1,250RPM & 50-70Ncm Torque.



Drill In **REVERSE** Using "Up & Down" Motion To Prepare 1-2mm Deep Dimple Into Top Of Broken Screw.  
**Use Irrigation To Minimize Heat.**



Suction To Remove Metal Shavings.  
Then Insert Tap Into Implant Handpiece  
Set Motor To **REVERSE** At 70-80RPM & 50-70Ncm Torque.



Insert Tap Into The 1-2mm Dimple In The Top Of The Broken Screw.  
Use The Tap In **REVERSE** To Remove Broken Screw.



Broken Screw Removed.

**Failed Implant Removal**

- Removes Failed Implants Without Compromising Surrounding Bone Or Damaging Neighboring Structures
- Works With Any Threaded Implant System
- Kit Includes Small, Medium And Large Fixture Removers



Insert Fixture Remover Screw Into Hand Adapter.



Turn Counter-Clockwise Into The Implant.



Use Wrench Counter-Clockwise Until The Implant Becomes Mobile.



Remove Failed Implant.



For Difficult Cases: Trephine Top 3-4mm Of Bone.

Centrifuge



**Variable Speed Centrifuge**

- Adjustable Speed Range Of 500rpm - 4,000rpm
- Compact Size 10.2" x 11.8" x 8" (26cm x 30cm x 20cm)
- Very Quiet Sealed Motor
- 1 Year Parts & Labor Warranty
- 110 Volts

#CENTRIFUGE-VARISPEED..... 1460.00



**"Rutkowski" Blood Collection Starter Package**

Disposables Package For Approximately 50 Patients  
Includes:

- Box Of 50 Vacutainer® Needle Holders
- Box Of 25 Latex Free Tourniquets
- 1 Blood Collection Tube Rack
- Pkg Of 100 Red Top Vacutainer® Tubes
- Pkg Of 100 Yellow Top Vacutainer® Tubes
- Pkg Of 100 3cc Sterile Syringes
- Box Of 50 Butterfly To Vacutainer® Adapters
- PRF Box

#BLOOD-COLL-RUTKOWSKI  
..... 850.00/PKG FOR APPROX 50 PATIENTS

*Disposable Cost Approximately 17.00 Per Patient*

**PRF Box**



**PRF Box**

- Form Fibrin Membrane Or Plug Shape From Clot
- Weighted Top Creates 1mm Thick Membrane - No Force Needed

#PRF-BOX.....339.00



Form Fibrin Membrane Shape From Clot



Form Fibrin Plug Shape From Clot



BIO-PRF Centrifuge



**BIO-PRF Horizontal Centrifuge**

- Up To 4X More Platelets And Leukocytes
- Higher Growth Factor Release When Compared To Fixed-Angle Centrifugation
- Better Horizontal Layer Separation Between PRF-Clot And Red Blood Cells
- More Even Distribution Of Regenerative Cells Throughout The PRF-Clot
- Less Cell Damage / Death On The Tube Walls Produced On Fixed-Angle Centrifugation
- Less RBC Accumulation

**Includes:**

- BIO-PRF Centrifuge
- BIO-PRF Box
- Set Of 6 BIO-PRF Instruments
- BIO-PRF Bowl - For Sticky Bone
- BIO-PRF Tray - For Membranes
- BIO-PRF Mixing Bowl
- BIO-PRF 24 Tube Holders
- BIO-PRF Latex Free Tourniquet
- BIO-PRF Cassette
- Box Of 100 BIO-PRF Red Tubes
- Box Of 100 BIO-PRF Blue Tubes
- Box Of 24 BIO-PRF Butterfly Needles

#BIO-PRF-COMP-KIT ..... 3450.00



**BIO-PRF Red Tubes**

#BIO-PRF-RED-TUBES  
..... 135.00 BOX OF 100

**BIO-PRF Blue Tubes**

#BIO-PRF-BLUE-TUBES  
..... 115.00 BOX OF 100

BIO-HEAT System



**BIO-HEAT System To Extend PRF Resorption**

- Extend PRF Resorption From 2-3 Weeks To 4-6 Months

**Indicated For:**

- Barrier Membrane For GBR Procedures
- Covering The Lateral Window During Sinus Lifts
- Root Coverage
- Mixing With Bone Grafting Materials
- Insertion Into Perio Pockets Non-Surgically For Stability

#BIO-HEAT-KIT ..... 2050.00

Blood Collection



**Basic Blood Collection Setup**

Vacutainer® Needle 21 Ga x 1" (2.54cm)  
**#VACUTAIN-NEEDLE . . . . . 71.60 BOX OF 100**

Vacutainer® Needle Holder  
**#VACUTAIN-HOLDER . . . . . 50.00 BOX OF 50**

IV Adapter  
**#BIO-PRF-IV-CONNECT . . . . . 199.00 BOX OF 100**

Tourniquet-Latex Free  
**#VACUTAIN-TOURNIQUET . . . . . 36.10 BOX OF 25**

Vacutainer® Tube-Red - 10mL - No Additives  
**#VACUTAIN-RED-TUBE . . . . . 142.00 PKG OF 100**

Vacutainer® Tube-Yellow - 10mL (8.5mL Draw) Citrate Additive  
**#VACU-TUBE-YELLOW . . . . . 162.90 PKG OF 100**

10cc Sterile Syringe  
**#SYRINGE-10CC . . . . . 68.90 PKG OF 100**

3cc Sterile Syringe  
**#SYRINGE-STERILE-3CC . . . . . 64.50 PKG OF 100**

Blunt Catheter Sterile 16 Ga x 3.5" (9cm)  
**#BLUNT-CATH-16G-9CM . . . . . 389.00 BOX OF 100**

Blunt Catheter Sterile 18 Ga x 1" (2.54cm)  
**#BLUNT-CATH-18G-2.5CM . . . . . 121.90 BOX OF 100**

Blood Collection Tube Rack  
**#VACU-TUBE-RACK . . . . . 37.60 EACH**

3cc Sterile Syringe With 21 Ga x 1.5" (3.81cm) Catheter  
**#SYRINGE-3CC-21G . . . . . 60.80 BOX OF 100**

Butterfly To Vacutainer® Adapter 21 Ga x .75" (1.9cm)  
**#BUTTERFLY-21G . . . . . 102.80 BOX OF 50**

**Rutkowski "Bio-Compress" Instrument**

Closes to 1mm Thickness To Create Buffy Coat Membrane  
**#BIO-COMPRESS . . . . . 197.00 EACH**

*Vacutainer® is a registered trademark of Becton, Dickinson and Company*

**Penguin<sup>RFA</sup> Implant Stability Monitor (Resonance Frequency Analysis)**

- *Easy-To-Use, Reliable & Affordable Way To Measure Implant Stability*
- *Cordless & Lightweight*
- *Provides Accurate ISQ Measurement*

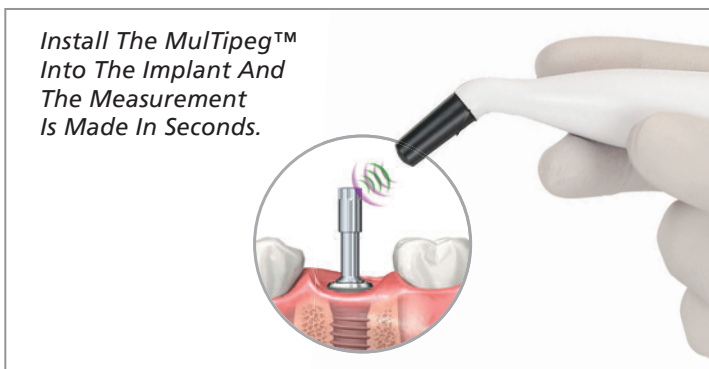

**Penguin<sup>RFA</sup> Implant Stability Monitor (Resonance Frequency Analysis)**

- **Includes:** Charging Cable And MultiPeg<sup>TM</sup> Driver
- 2 Year Warranty

#PENGUIN .....2290.00

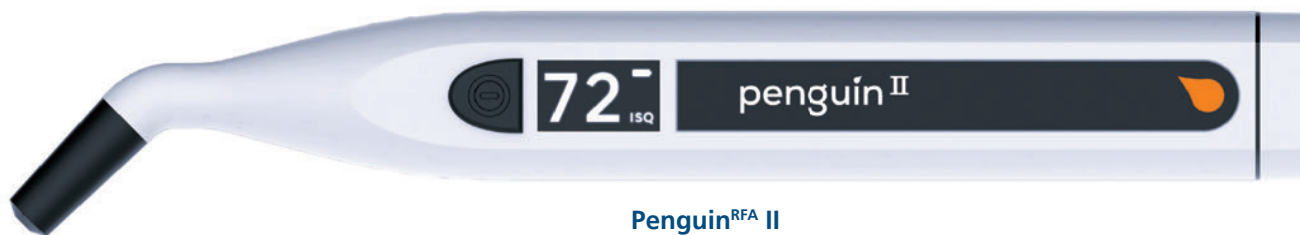

**Penguin<sup>RFA</sup> II**

- **Includes:** Stand-Up Wireless Charging Base, MultiPeg<sup>TM</sup> Driver, And ISQ Test Peg
- Rubberized Grip For Easy Handling
- 2 Year Warranty

#PENGUIN-2 .....2490.00



**MultiPeg<sup>TM</sup> Multi-Use Sensing Devices**

- Available For All Major Implant Systems
- Made Of Durable, Tissue Friendly Titanium
- Laser Marked With Type Number
- ISQ Standard Calibrated<sup>TM</sup>
- Autoclavable Up To 20 Times

**CALL TO CONFIRM WHICH PEGS YOU NEED**



Salvin Titanium Bone Tacks



Scan For



Tack System  
Technique Guide

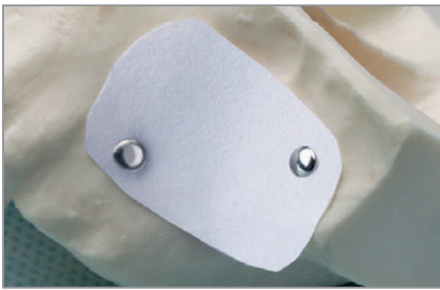

- Available In 3mm & 5mm Lengths
- Packaged 5 Tacks To A Vial, Non-Sterile
- Head Of Tack Is 2.5mm Diameter

**3MM LENGTH**  
#TACK-3-PT ..... 70.90 PKG OF 5

**5MM LENGTH**  
#TACK-5-PT ..... 70.90 PKG OF 5

Use Tacks To Secure Membrane Over Surgical Site

Salvin Tack Kits Available With Either:

Mallet & Placement Instrument



Load Tack On Instrument



Lightly Tap To Place Tack

Or Spring Loaded PowerTack™ Delivery Handle



Pull End To Activate PowerTack™ Delivery Handle



Load Tack On Tip Of Handle



Push Button To Place Tack

Meisinger "Pin Control" Membrane Fixation Kit

- **Fixation Of Resorbable Membranes, Non-Resorbable Membranes & Titanium Mesh**
- **Hybrid Screw & Pin Easily Removed With Hand Screwdriver**

Designed By Dr. Istvan Urban

Includes:

- 2 1.8mm Latch-Type Tri-Spade Pilot Drills
- 2 0.8mm Latch-Type Twist Perforation Drills
- 2 0.6mm Latch-Type Twist Perforation Drills
- 1 Placement Instrument
- 1 Fixation Handle
- 1 Hand Screwdriver

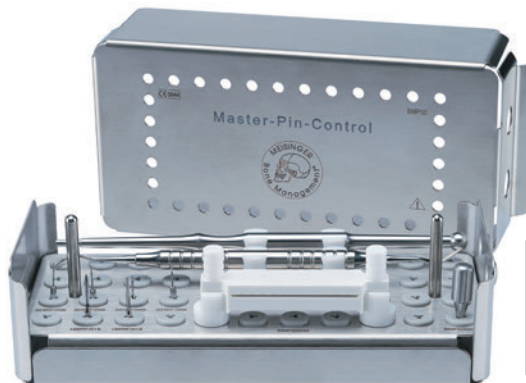

Basic Kit With 10 Pins

#MEIS-BMPBA ..... 1318.35 KIT

Master Kit With 34 Pins

#MEIS-BMP00 ..... 1649.35 KIT

Replacement Pins - 3.5mm Length

10 Pins, Non-Sterile  
#MEIS-MP10..... 228.50 PKG OF 10

**SPECIAL**

**Salvin Membrane Tack Kit With Mallet & Placement Instrument**



**MOST POPULAR**

**Includes:**

- 25 Tacks
- Autoclavable Tack Block
- Tack Placement Instrument
- Tack Mallet
- Tack Drill For Dense Cortical Bone

REGULAR PRICE IS 919.20

SAVE 230.20

#TACK-KIT-TI ..... 689.00 KIT



**For The Salvin Membrane Tack Kit With Mallet**



Titanium Tack Forcep

#TACK-FORCEP ..... 132.50 EACH



Optional Offset Tack Instrument

#TACK-INSTR-OFFSET ..... 201.40 EACH



Replacement Tack Pilot Drill

#TACK-DRILL ..... 67.90 EACH

**SPECIAL**

**Salvin Membrane Tack Kit With PowerTack™ Handle**



**Includes:**

- 20 Tacks
- Autoclavable Tack Block
- PowerTack™ Delivery Handle
- Tack Forcep

REGULAR PRICE IS 1352.10

SAVE 276.10

#POWERTACK-KIT ..... 1076.00 KIT



**If You Already Have Our Regular Tack Kit**

**Includes:**

PowerTack™ Delivery Handle, Autoclavable Tack Block

#POWERTACK ..... 936.00 HANDLE & BLOCK

Membrane Placement Instruments



**Membrane Forcep  
With Ring Tip**

Non-Serrated For Membranes  
#MEMB-RING-FORC  
..... 117.50 EACH



**Membrane Forcep  
"Smooth Tip"**

Non-Serrated For Membranes  
#MEMB-FORCEP  
..... 87.10 EACH



**MOST POPULAR**

**Membrane Forcep  
"Paddle Tip"**

Non-Serrated For Membranes  
#MEMB-PADDLE-FORCEP  
..... 87.10 EACH



**Membrane Forcep - Long  
"Paddle Tip"**

Non-Serrated For Membranes  
#MEMB-PADDLE-LONG  
..... 87.10 EACH



**MOST POPULAR**

**SuperCut Iris Curved 11cm**

Ideal For Delicate Membranes  
#SC IRIS CU  
..... 138.40 EACH



**MOST POPULAR**

**Membrane Placement Instrument**

Micro-Point Tip For Precise Placement & Manipulation Of Membranes  
#MEMB-PLACER..... 77.80 EACH



**Membrane Positioner**

Stabilize & Condense  
Designed By Dr. Larry Towning  
#MEMB-CONDENSER  
..... 119.80 EACH

**Membrane Placement Instruments**

**Membrane / PRF Forceps With  
"Peanut" Shaped Tip**

Designed By Dr. Brad Fulkerson



*Tip Holds Membrane  
Or Fibrin Clot Flat  
While Placing In  
Tight Spaces*



*Use The Peanut  
Shape Tip As  
A Trimming Template  
For Socket Grafting*

For Placement In Right Side Of Patient

**#MEMB-FORC-BF-PEANUTR . . . 117.60 EACH**



For Placement In Left Side Of Patient

**#MEMB-FORC-BF-PEANUTL . . . 117.60 EACH**



**Membrane Forcep With  
"Ice Cream Cone" Shaped Tip**

Designed By Dr. Brad Fulkerson

**#MEMB-FORC-BF-CONE . . . . . 117.60 EACH**



*Use The Cone Shape Tip As A  
Trimming Template For Buccal Defects*



**Salvin Mesh-Ti™ Titanium Mesh**



**For Large Defects**

- 0.2mm Thickness
- 1.48mm (1,480 Micron) Pore Size
- Larger Pore Size For Enhanced Growth Factor Cross Over
- Secure With Salvin Fixation Screws
- Packaged Non-Sterile

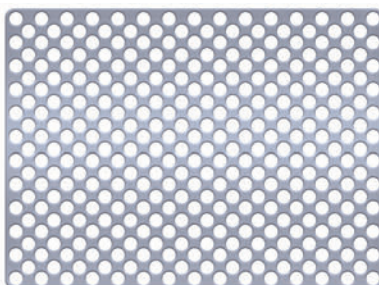

*Shown Actual Size*

**50mm x 37mm**

**#SALVIN-TI-MESH-50X37 . . . . . 112.50 EACH**

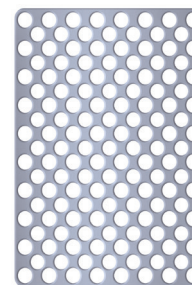

*Shown Actual Size*

**25mm x 37mm**

**#SALVIN-TI-MESH-25X37 . . . . . 72.20 EACH**

**Mesh & Wire Cutter**

**#MESH-WIRE-CUTTER**

**. . . . . 193.20 EACH**





Salvin Titanium **Tenting** Screws



Photo: Dr. Nick Shumaker

5mm Diameter Head Provides Broad Surface Area During GBR Tenting Procedures

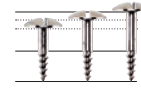



Screws Have 4mm Of Thread For Stabilization In Bone

Available With 3, 4 or 5mm Unthreaded Surface For Each Unique Case



**Tenting**

Dental Latch Friction Fit Screwdriver   
 #FIX-DRIVER-LATCH. . . . . 104.50 EACH

Drill Bit-Dental Latch (1.1mm)   
 #FIX-DRILL-RA . . . . . 104.50 EACH

1.5mm Diameter Tenting Screws - 5mm Diameter Head		
1.5mm x 7mm Tenting Screw	#TENT-1.5X7	52.70 EACH
1.5mm x 8mm Tenting Screw	#TENT-1.5X8	52.70 EACH
1.5mm x 9mm Tenting Screw	#TENT-1.5X9	52.70 EACH

**SPECIAL**

**Salvin Tenting Screw Kit**

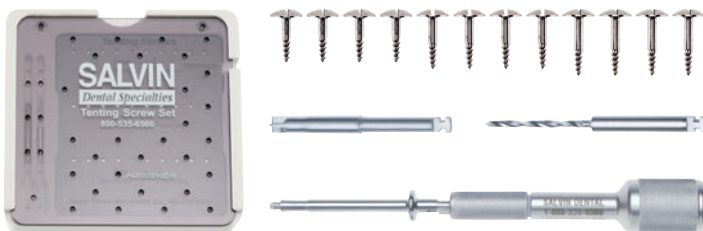

**Includes:**

- 12 Tenting Screws (Your Assortment)
- Bone Fixation Screwdriver
- Latch Screwdriver
- Latch Drill Bit
- Autoclavable Organizer Block

**REGULAR PRICE OF COMPONENTS IS 1630.40**

**SAVE 554.40**

**#TENT-KIT-W/DRIVER. . . . . 1076.00 KIT**

*Screwdriver Tips Are Proprietary To Manufacturer's Screw System And Are Not Interchangeable  
 The Salvin Fixation Screwdriver Works With Both Our Fixation Screws And Our Tenting Screws*

Salvin Titanium Fixation Screws

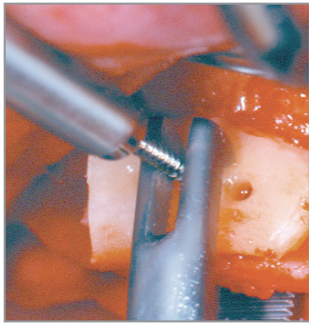



Photo: Dr. Yvan Poitras

Use To Secure Autogenous or Allograft Bone Blocks In The Mandible Or Maxilla

Dental Latch Friction Fit Screwdriver   
#FIX-DRIVER-LATCH..... 104.50 EACH

Drill Bit-Dental Latch (1.1mm)   
#FIX-DRILL-RA ..... 104.50 EACH

Lag Drill Bit-Dental Latch (1.5mm)   
Oversize Drill Bit For Drilling Enlarged Hole In Graft  
#FIX-DRILL-LAG ..... 104.50 EACH

  
Drill Bit-Straight Handpiece (1.1mm)  
#FIX-DRILL-HP ..... 104.50 EACH

  
Lag Drill Bit-Straight Handpiece (1.5mm)  
Oversize Drill Bit For Drilling Enlarged Hole In Graft  
#FIX-LAG-DRILL-HP ..... 104.50 EACH

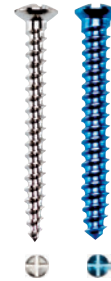

Locking Tip Driver Keeps Screw Secure Until You're Ready To Release It



Block Fixation

1.5mm Diameter Screws - 3mm Diameter Head		
1.5mm x 4mm Bone Screw	#FIX-1.5X4-PT	52.70 EACH
1.5mm x 6mm Bone Screw	#FIX-1.5X6-PT	52.70 EACH
1.5mm x 8mm Bone Screw	#FIX-1.5X8-PT	52.70 EACH
1.5mm x 10mm Bone Screw	#FIX-1.5X10-PT	52.70 EACH
1.5mm x 13mm Bone Screw	#FIX-1.5X13-PT	52.70 EACH
1.5mm x 15mm Bone Screw	#FIX-1.5X15-PT	52.70 EACH

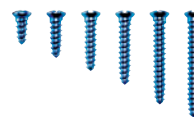

Block Fixation

2.0mm Diameter Emergency Screws - 3mm Diameter Head		
2.0mm x 4mm Bone Screw	#FIX-2.0X4-PT	52.70 EACH
2.0mm x 6mm Bone Screw	#FIX-2.0X6-PT	52.70 EACH
2.0mm x 8mm Bone Screw	#FIX-2.0X8-PT	52.70 EACH
2.0mm x 10mm Bone Screw	#FIX-2.0X10-PT	52.70 EACH
2.0mm x 13mm Bone Screw	#FIX-2.0X13-PT	52.70 EACH
2.0mm x 15mm Bone Screw	#FIX-2.0X15-PT	52.70 EACH

SPECIAL

Salvin Block Fixation Screw Kit

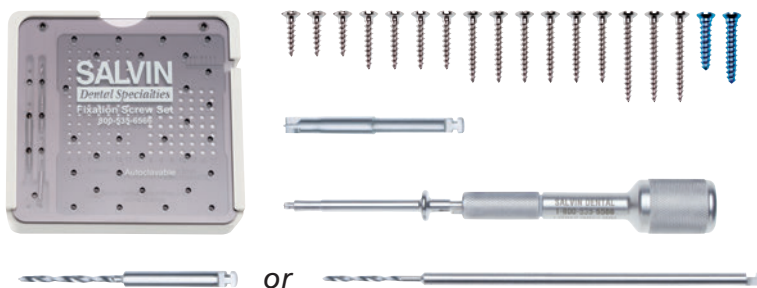

Includes:

- 18 Fixation Screws (Your Assortment)
- Latch Screwdriver
- Bone Fixation Screwdriver
- Drill Bit (Latch or Straight HP)
- Lag Bit (Latch or Straight HP)
- Autoclavable Organizer Block

REGULAR PRICE OF COMPONENTS IS 2051.10

SAVE 631.10

#FIX-KIT-SPECIAL ..... 1420.00 KIT



Bone Block Clamps  
On Page 94

BUYER'S GUIDE - MONITORS

Criticare nGenuity™ 8100  
Page 20



- ▶ Pulse Rate
- ▶ O<sub>2</sub> Saturation
- ▶ Auto Blood Pressure
- ▶ Electrocardiogram
- ▶ Expired CO<sub>2</sub>

Zoe Medical Nightingale™ PPM3  
Page 20



- ▶ Pulse Rate
- ▶ O<sub>2</sub> Saturation
- ▶ Auto Blood Pressure
- ▶ Electrocardiogram
- ▶ Expired CO<sub>2</sub>

Mindray ePM 10A  
Page 21

**MOST POPULAR**



- ▶ Pulse Rate
- ▶ O<sub>2</sub> Saturation
- ▶ Auto Blood Pressure
- ▶ Electrocardiogram
- ▶ Expired CO<sub>2</sub>

Criticare eQuality™ 506  
Page 19



- ▶ Pulse Rate
- ▶ O<sub>2</sub> Saturation
- ▶ Auto Blood Pressure

Mindray VS8  
Page 19

**MOST POPULAR**



- ▶ Pulse Rate
- ▶ O<sub>2</sub> Saturation
- ▶ Auto Blood Pressure

**BUYER'S GUIDE -  
FOR MONITORS ON THIS PAGE**

▶	Pulse Rate
▶	O <sub>2</sub> Saturation
▶	Auto Blood Pressure

**Mindray VS8**

**MOST POPULAR**

- 8.4" Touchscreen Color LCD Display
- Nellcor OxiMax SpO<sub>2</sub>
- Built-In Printer
- Three Year Warranty

#MINDRAY-VS8

*Call For Lowest Price*

**Latexfree**  
PRESSURE CUFF



Built-In Printer



**Roll Stand For Mindray VS8**

Quick Release Mount & Cable Management

#MINDRAY-ROLL-STAND-VS-EPM

..... CALL FOR PRICE

**Criticare eQuality™ 506**

- **ComfortCuff™** Measures On Inflation For Fast, Comfortable Readings

#CR-506-EQUALITY

*Call For Lowest Price*



**Latexfree**  
PRESSURE CUFF



Bluetooth Printer Included



**Roll Stand For eQuality™ 506 Monitor**

Adjusts 37" To 47" High, 20" Diameter Base

#CR-ROLL-506 ..... CALL FOR PRICE



**BUYER'S GUIDE -  
FOR MONITORS ON THIS PAGE**

▶	Pulse Rate
▶	O <sub>2</sub> Saturation
▶	Auto Blood Pressure
▶	Electrocardiogram
▶	Expired CO <sub>2</sub>



**Zoe Medical Nightingale™ PPM3**

- Connectivity With Major Dental EMR Systems
- Masimo ISA CO<sub>2</sub> Analyzer
- Built-In Printer
- Three Year Warranty



WITH CO<sub>2</sub>  
#ZOE-PPM3-CO2



WITHOUT CO<sub>2</sub>  
#ZOE-PPM3

*Call For Lowest Price*

**Roll Stand For Zoe Medical  
Nightingale™ PPM3 Monitor**

21" Diameter Base

#ZOE-PPM3-ROLL-STAND . . CALL FOR PRICE



**Criticare nGenuity™ 8100**



- **ComfortCuff™** Measures On Inflation For Fast, Comfortable Readings
- Three Lead ECG With Freeze & Cascade
- Built-In Printer

WITH CO<sub>2</sub>  
#CR-NGENUITY-CO2

WITHOUT CO<sub>2</sub>  
#CR-NGENUITY-8100

*Call For Lowest Price*

**Latexfree**  
PRESSURE CUFF



**Roll Stand For nGenuity™ 8100 Monitor**

Adjusts 37" To 47" High, 20" Diameter Base

#CR-ROLL-8100 . . . . .CALL FOR PRICE



	Pulse Rate
	O <sub>2</sub> Saturation
	Auto Blood Pressure
	Electrocardiogram
	Expired CO <sub>2</sub>

**Mindray ePM 10A** **MOST POPULAR**

- 10" Multi-Gesture Touchscreen Display
- Extensive Data Storage Capability For Trend Data, Alarms, And Events
- Integrated Sidestream CO<sub>2</sub>
- Built-In Printer
- Three Year Warranty



**WITH CO<sub>2</sub>**  
#MINDRAY-EPM-10A-CO2



**WITHOUT CO<sub>2</sub>**  
#MINDRAY-EPM-10A

*Call For Lowest Price*

**Roll Stand For Mindray ePM 10A Monitor**

21" Diameter Base

#MINDRAY-ROLL-STAND-VS-EPM... CALL FOR PRICE



**CO<sub>2</sub> Monitor Accessories**



**CO<sub>2</sub> Monitor Single Cannula**

- Single Use
- For CO<sub>2</sub> Use Only

#CANNULA-SINGLE

..... 94.90 BOX OF 50



**CO<sub>2</sub> Monitor Divided Cannula**

- Single Use
- Works With Any O<sub>2</sub> System

#CANNULA-DIVIDED

..... 94.90 BOX OF 25



**CO<sub>2</sub> Monitor Sample Line**

- Replace Every 20 Uses
- Connects Cannula & Water Trap

#SAMPLE-LINE

..... 108.90 BOX OF 50



**Zoe Water Trap**

330 Working Hours

#ZOE-WATER-TRAP ..... 47.90 EACH

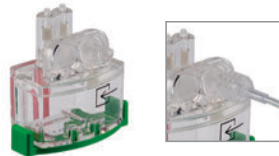

**Criticare nGenuity™ Water Trap**

- Replace Every 20 Uses
- Water Trap & Filter

#CR-938-FNC ..... 559.00 BOX OF 30



**Mindray Water Trap**

- For Use Up To One Month

#MINDRAY-EPM10A-CO2-WATER-TRAP  
..... 66.00 BOX OF 2

### Precordial Amplified Sedation Stethoscope

- Chest Piece With Built-In Microphone Amplifies Lung Sounds While Suppressing Room Noise
- Diagnostic Quality Sound, Less Ambient Noise
- Set Includes:
  - Precordial Amplifier
  - Volume Controlled Earbuds
  - Precordial Pickup Cable With Piezo Chest Piece
  - 2 AAA Batteries
  - Manual & Case



#### Wireless Bluetooth® Integrated Technology

#PRE-STETH-WIRELESS . . . . . 736.00 SET

### Zoll AED PLUS™ Automated External Defibrillator



- One-Piece, Pre-Connected Electrode With CPR Feedback
- Sensor Tells You If You Are Pressing At The Correct Rate
- Pictures, Text Displays & Voice Prompts Ensure Proper Sequence
- Auto Adjusts Shock Based On Detected Body Mass
- Works With Both Adults & Children
- Includes: Carry Case, Adult Electrodes, Batteries, Prep Kit & Video
- Memory Allows Download Of Rescue Data With Included Software
- Automatically Self-Tests Defibrillator, Battery & Pad Daily
- Uses 5-Year Lithium-123 Duracell Camera Batteries



#ZOLL-AED-PLUS

*Call For Lowest Price*

### Zoll Replacement Electrodes

#### 5 Year Adult Electrodes

#ZOLL-AED-ELECTRODE . . . . .227.00 SET

#### 2 Year Pedo Electrodes

#ZOLL-AED-PEDO-ELECTR. . . . .151.00 SET



**CO<sub>2</sub> Capnography Nasal Hoods**

- Nasal Hood With Quick Connect To Capnography Monitor Tubing
- For Delivery & Scavenging Of Nitrous Oxide & End-Tidal CO<sub>2</sub> Capnography Monitoring
- Secure Female Luer Lock Sample Line Connection



**Latexfree**

**CO<sub>2</sub> Capnography Nasal Hoods**

Unscented Gray - Single Use

#ACC-CO2-HOOD-GRAY . . . . . 135.90 BOX OF 12

**ECG Patches & Wrist Clips**

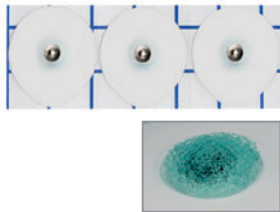

**ECG Patches - Wet Gel Foam**

- Snap Connectors For ECG Leads
- Wet Gel Foam Electrodes
- Recommended For Use With Zoe ECG Monitors

#CR-LEADLOCK-50

1 BOX . . . . . 29.90 BOX OF 50  
2 OR MORE . . . . . 27.90 BOX OF 50



**ECG Wrist Clips**

- Snap Connectors For ECG Leads
- Left Wrist Clip Has 2 Leads & Right Wrist Clip Has 1 Lead Of A 3 Lead ECG
- Use Conductive (#SIGNA-SPRAY) Solution For Best Results

#CR 1166 . . . . . 130.20 PAIR



**ECG Patches**

- Snap Connectors For ECG Leads
- Packaged In Sets Of 3

#CR-LEADLOCK-20

1 BOX . . . . . 29.90 BOX OF 20 SETS  
2 OR MORE . . . . . 27.90 BOX OF 20 SETS



**Conductive Solution For ECG Wrist Clips**

- Use With ECG Snap Leads
- 250mL Bottle

#SIGNA-SPRAY . . . . . 16.30 EACH

**Criticare Blood Pressure Cuffs**



Quick Connect Adapter Fits Single Hose Criticare Monitors

**Child**

#CR-474 . . . . . 72.50 EACH

**Regular**

#CR-475 . . . . . 72.50 EACH

**Large Adult**

#CR-476 . . . . . 97.60 EACH



Nasal Cannula & Oxygen Adapter



Soft-Touch For Comfort

Latexfree

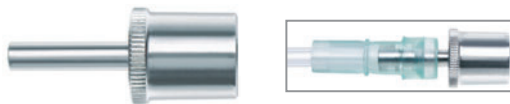

**MOST POPULAR**

**Soft-Touch Adult Nasal Cannula**

- Curved Tips For Excellent Patient Comfort
- Crush Resistant Tubing
- Individually Packaged - 7' (2.1m) Long

#NASAL-CANNULA

BOX OF 50 .....	.80.90 BOX
2 OR MORE BOXES .....	.75.20 BOX

**Nitrous System Adapter For Nasal Cannula Tubing**

FOR OXYGEN USE BY ITSELF ONLY  
USE YOUR SCAVENGER CIRCUIT WHEN USING NITROUS

#ACC-CANNULA-ADAPT .....	.74.70 EACH
--------------------------	-------------

Pocket CPR Mask & Emergency Airways



**Single Use Laryngeal Mask Airways (LMA)**

- Set Of 3 Allows Rapid Airway Access
- Less Invasive Than An Endotracheal Tube
- Includes #3 (Pedo To Small Adult), #4 (Adult) & #5 (Large Adult)

#LMA-SET-OF-3 .....	72.90 SET OF 3
2 OR MORE .....	67.50 SET OF 3



**Guedel Airways**

- Airway, Bite Block & Tongue Depressor
- Coated Plastic Prevents Crimping & Protects Teeth
- 100mm, 90mm, 80mm

#GUEDEL-SET .....	14.50 SET OF 3
3 OR MORE .....	12.60 SET OF 3



**MOST POPULAR**

**Nasopharyngeal Airway Set**

- Set Of 9 Single Use Airways
- Soft, Flexible Mediprene Material
- Includes Sizes 20 Fr, 22 Fr, 24 Fr, 26 Fr, 28 Fr, 30 Fr, 32 Fr, 34 Fr & 36 Fr

#NASO-KIT-20-36 .....	102.90 SET OF 9
2 OR MORE .....	94.40 SET OF 9

Anesthesia Instrumentation

**Magill Endotracheal Forcep**

12cm Shaft Length  
 #MAGILL . . . . . 139.90 EACH  
 3 OR MORE . . . . . 131.10 EACH



**Young Forcep**

17.1cm  
 #YOUNG-FORCEP . . . . . 220.70 EACH  
 3 OR MORE . . . . . 208.10 EACH



**Replacement Tips For Young Forcep**

Set Of 2  
 #YOUNG-FORCEP-TIPS . . . . . 16.90 SET OF 2  
 3 OR MORE . . . . . 15.10 SET OF 2

**MOST POPULAR**

**Yankauer Suction Tip**

29.8cm  
 #YANKAUER. . . . . 77.60 EACH  
 3 OR MORE . . . . . 71.90 EACH



**Disposable Sterile Yankauer Tips**

- Blue Translucent Plastic Minimizes Visibility Of Fluids
- Flange Tip & Vent

#YANKAUER-DISPOSABLE  
 BOX OF 50 . . . . . 132.90 BOX  
 2 OR MORE . . . . . 123.60 BOX



*To Use These Surgical Tips With The High Volume Suction In Your Office, Use Our Tubing Adapter On Page 145*

Emergency Kits



**MOST POPULAR**

**Manual Single-Use Resuscitator**

- Adult Face Mask
- Attached Ventilation Bag
- Connects To Oxygen Outlet For Nasal Cannula

#RESUS-SINGLE . . . . . 47.90 EACH  
 2 OR MORE . . . . . 44.40 EACH



**MOST POPULAR**



**Single-Use Emergency Suction**

- Easy To Pump, Even With Small Hands
- Suctions Into Self Contained Reservoir Bag
- Use Metal Aspirator Or Plastic Yankauer
- 1000cc Fluid Capacity

#EMERGENCY-SUCTION . . . . . 81.40 EACH  
 2 OR MORE . . . . . 75.10 EACH

Scan For  
**Emergency Suction  
 Technique Guide**



**Single-Use Adult Emergency Cricothyrotomy Kit**

- Quick & Safe Access For Ventilation In Presence Of Acute Respiratory Distress With Upper Airway Obstruction
- Contains Pre-Assembled Emergency Cricothyrotomy Unit With 10mL Syringe, Padded Strap, Connecting Tube

#CRIC-KIT . . . . . 307.70 EACH

OraFOAM™ Absorbable Collagen Hemostatic Sponges



Package Contains 18 Sponges

Absorbable Collagen Hemostatic Sponges

- 0.5" x 1" (1.27cm x 2.54cm)
- Controls Bleeding In 2 To 5 Minutes
- Coherent Sponge Structure Allows Easily Controlled Application

#ORAFOAM-PKG-18 .....	311.00 BOX OF 18
2 OR MORE BOXES .....	296.30 BOX OF 18

OraFOAM™ Hemostatic Sponge Is Indicated In Surgical Procedures (Other Than Ophthalmological & Urological Surgery) As An Adjunct To Hemostasis When Control Of Bleeding By Ligature Or Conventional Procedures Is Ineffective Or Impractical. Please See Product IFU For Precautions & Adverse Reactions. IFU Available Online At [www.salvin.com/Downloads/Guides-Studies.html](http://www.salvin.com/Downloads/Guides-Studies.html)

BloodSTOP® Absorbent Hemostatic Gauze



BloodSTOP® Absorbent Hemostatic Gauze

- Made Of 100% Natural Cellulose
- Accelerates Coagulation
- Reduces Healing Time & Recurring Bleeding

BloodSTOP® 0.5" x 2"

#BLOODSTOP-IX-0.5X2 .....	180.50 BOX OF 24
2 OR MORE BOXES .....	171.70 BOX OF 24

BloodSTOP® 2" x 2"

#BLOODSTOP-IX-2X2 .....	309.00 BOX OF 12
2 OR MORE BOXES .....	294.30 BOX OF 12

Hemostats



Mosquito Hemostat  
12.7cm

#MOSQ-CURV-5  
..... 69.10 EACH

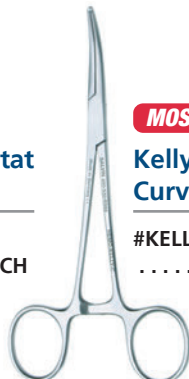

**MOST POPULAR**  
Kelly Hemostat  
Curved - 14cm

#KELLY-CURV-HEMO  
..... 69.10 EACH

Bone Wax



- Packaged Sterile In 2.5 Gram Pouch For Easy Dispensing
- Made From Beeswax & Other Natural Materials

#BONE-WAX BOX OF 12 TUBES .....	129.90 BOX
2 OR MORE .....	123.40 BOX



### HemCon® Dental DressingPro

- *Easy To Use – Adhesive Properties Help Secure Dressing To Mucosal Tissue*
- *Safe – Protects The Wound Surface With No Known Contra-Indications*





"I have used HemCon® for many years to rapidly and predictably control bleeding during surgery. I highly recommend it to my students at the Misch Resnik Implant Institute."

**–Dr. Randy Resnik**  
Prosthodontist, Pittsburgh, PA

\*Clinical Studies On File

Package Contains 12 Dressings  
Dressings Shown Actual Size



10mm x 12mm  
Best For Extraction Sockets



1" x 3" (25mm x 75mm)  
Best For Palatal Wound Sites

#### HemCon® Dental DressingPro 10mm x 12mm

#HEMCON-10X12MM . . . . . 186.00 BOX OF 12  
2 OR MORE BOXES . . . . . 176.90 BOX OF 12

#### HemCon® Dental DressingPro 1" x 3" (25mm x75mm)

#HEMCON-1X3INCH . . . . . 272.00 BOX OF 12  
2 OR MORE BOXES . . . . . 258.70 BOX OF 12

### Portable Electrocautery System



#### Complete Set Includes:

- Handle & Batteries
- 2 Fine Tips & 2 Loop Tips
- 10 Sterile Handle Sheaths

#CAUT-KIT-DEL-1 . . . . . 126.50 SET



#### Replacement "Fine" Tips

Box Of 10 Single Use "Fine" Tips  
With Sterile Handle Sheaths

#CAUT-FINE-H101 . . . . . 86.40 BOX OF 10



#### Replacement "Loop" Tips

Box Of 10 Single Use "Loop" Tips  
With Sterile Handle Sheaths

#CAUT-LOOP-H103 . . . . . 86.40 BOX OF 10



PeriAcryl® by GluStitch



Purified Cyanoacrylate Dental Adhesive

- Will Adhere To Moist Living Tissue Without Toxic Or Foreign Body Reaction
- Deep Violet Color Provides Visibility For Controlled Placement
- One Year Guaranteed Shelf Life



Single-Use Applicators Kit

Includes: 12 0.2mL Pre-Loaded Applicators

#PERIACRYL-SINGLE ..... 125.20 BOX OF 12  
 2 OR MORE BOXES ..... 118.50 BOX OF 12



**MOST POPULAR**

5mL Bottle Multi-Use Kit

Includes: 5mL Bottle, 50 Pipettes & 1 Reusable Administration Tray

#PERIACRYL ..... 121.90 EACH  
 2 OR MORE ..... 112.10 EACH

High Viscosity PeriAcryl® by GluStitch

- *High Viscosity Helps Control Flow For Precision Application*
- *Nine Times Thicker Than Regular PeriAcryl For Easier Handling*

5mL Bottle Multi-Use Kit

Includes: 5mL Bottle, 50 Pipettes & 1 Reusable Administration Tray

#PERIACRYL-HV ..... 129.80 EACH  
 2 OR MORE ..... 121.50 EACH



Micropoint Suture Removal Scissors

*Takes The "Wince" Out Of Suture Removal, Even In Sensitive Tissue*



**MOST POPULAR**

Featherlite 14cm Curved

Delicate "Castroviejo Style" Scissors

#F-LITE5CURV ..... 325.00 EACH  
 3 OR MORE ..... 308.30 EACH

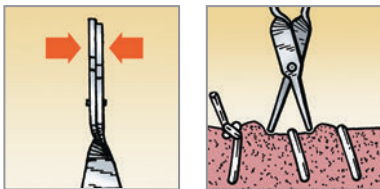

Opposing Spring Tips Maintain Force Between Blades For Incredible Cutting Without Pinching Tissue



*Complete Selection Of Suture Scissors On Pages 130-132*



NEEDLE SELECTION GUIDE

	<b>Reverse Cutting</b> Triangular point with cutting edge on the outer curvature.	
	<b>Premium Reverse Cutting</b> Same as Reverse Cutting, but precision-honed for added sharpness.	
	<b>Taper Point</b> Round shaft, straight or curved, tapered point with no cutting edge. Special tapered point needle for connective tissue grafts. Ideal for delicate tissue.	Special Tapered Point Needle For Connective Tissue Grafts
	<b>Taper Cutting</b> Four (4) cutting edges with a taper shaft. Useful in microsurgery for excellent penetration through tough skin.	

The Suture Book By Dr. Lee Silverstein

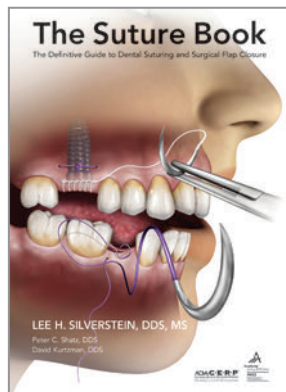

Beautifully Illustrated Step-By-Step Instructions

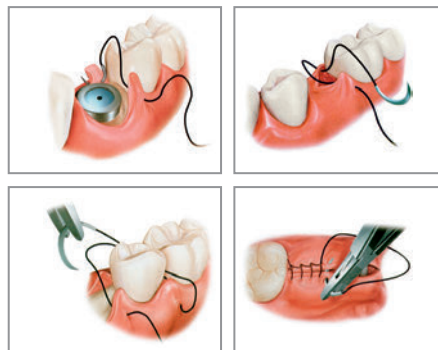

The Suture Book: The Definitive Guide To Dental Suturing And Surgical Flap Closure By Dr. Lee Silverstein

- Detailed, Illustrated Step-By-Step Instructions For Dental Suturing
- Characteristics Of Suture Materials & Needle Designs
- Suture Selection Recommendations For Various Procedures

#SUTURE-BOOK..... 99.00 EACH  
 6 OR MORE ..... 89.00 EACH



Complete Selection of Sutures  
 On Pages 30-33



Needle Holders  
 On Pages 126-129

# SALVIN® CytoSurg®



## Non-Resorbable PTFE Sutures

- *Excellent Choice For Bone Grafting & Implant Procedures*
- *Smooth & Flexible – Not Fragile Or Brittle – So Knots Stay Tied*
- *Proprietary Monofilament Is Biologically Inert & Non-Cytotoxic*
- *Longer Length – All PTFE Sutures Now 24" Long*





**Black Needle For Higher Visibility & Less Glare**  
Super Sharp Needle Requires Less Force – Easier Suturing With Less Trauma

*“Racetrack” Rather Than Zig-Zag Package*



*Little-To-No Package Memory For Excellent Handling And Secure Knotting*

*Ultra-Soft, Ultra-Smooth Suture Designed With Low Surface Porosity*

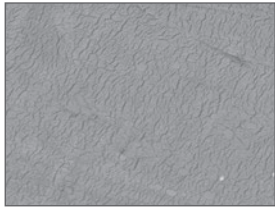
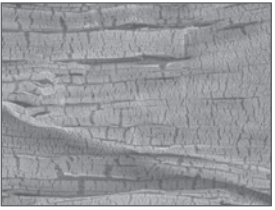
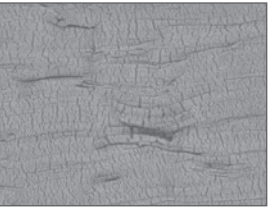
SALVIN **CytoSurg** Competitor G Competitor O  
(2000x Magnification)

	Salvin Item#	Size	Needle	Length	Per Box	10 Or More
	#PTFE-20FS2	2-0	19mm 3/8 Circle - Reverse Cutting	24" (60cm)	112.60 Box 12	100.90 Box 12
<span style="color: red; font-weight: bold;">MOST POPULAR</span>	#PTFE-30FS2	3-0	19mm 3/8 Circle - Reverse Cutting	24" (60cm)	112.60 Box 12	100.90 Box 12
	#PTFE-30FS3	3-0	16mm 3/8 Circle - Reverse Cutting	24" (60cm)	112.60 Box 12	100.90 Box 12
	#PTFE-40TF	4-0	13mm 1/2 Circle - <u>Taper Point</u>	24" (60cm)	112.60 Box 12	100.90 Box 12
<span style="color: red; font-weight: bold;">MOST POPULAR</span>	#PTFE-40FS3	4-0	16mm 3/8 Circle - Reverse Cutting	24" (60cm)	112.60 Box 12	100.90 Box 12
	#PTFE-40PS2	4-0	19mm 3/8 Circle - <u>Premium</u> Reverse Cutting	24" (60cm)	133.20 Box 12	119.50 Box 12
	#PTFE-40P3	4-0	13mm 3/8 Circle - <u>Premium</u> Reverse Cutting	24" (60cm)	133.20 Box 12	119.50 Box 12
	#PTFE-50P3	5-0	13mm 3/8 Circle - <u>Premium</u> Reverse Cutting	24" (60cm)	133.20 Box 12	119.50 Box 12
	#PTFE-60P3	6-0	13mm 3/8 Circle - <u>Premium</u> Reverse Cutting	24" (60cm)	133.20 Box 12	119.50 Box 12







**SALVIN® SurgiPoint® PGA Polyglycolic Acid Synthetic Absorbable-Braided**

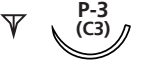

- Synthetic Absorbable, Braided Coated Polyglycolic Acid – Similar To Vicryl™ But Greater Tensile Strength
- Unique PolyGlide Coating For Smooth No-Drag Suture Passage Through Tissue

**Resorbs In 21-28 Days**

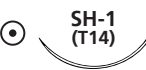

	Salvin Item#	Size	Needle	Length	Color	Vicryl™ Comparison	Per Box	10 Or More
▽  <b>FS-2 (C6)</b>	<b>#LV-423B</b>	3-0	3/8 Circle - Reverse Cutting	30" (76cm)	Undyed	J423G	85.50 Box 12	80.70 Box 12
	<b>#LV-422B</b>	4-0	3/8 Circle - Reverse Cutting	30" (76cm)	Undyed	J422G	85.50 Box 12	80.70 Box 12
	<b>#LV-MC397NC</b>	4-0	3/8 Circle - Reverse Cutting	30" (76cm)	Violet		125.60 Box 12	118.10 Box 12
	<b>#LV-421B</b>	5-0	3/8 Circle - Reverse Cutting	30" (76cm)	Undyed	J421G	85.50 Box 12	80.70 Box 12
▽  <b>FS-3 (C22)</b>	<b>#LV-500B</b>	5-0	3/8 Circle - Reverse Cutting	18" (45cm)	White	J500G	81.90 Box 12	78.10 Box 12
▽  <b>P-3 (C3)</b>	<b>#LV-493B</b>	5-0	3/8 Circle - <u>Prem</u> Reverse Cut	18" (45cm)	Undyed	J493G	148.50 Box 12	140.00 Box 12
	<b>#LV-492B</b>	6-0	3/8 Circle - <u>Prem</u> Reverse Cut	18" (45cm)	Undyed	J492G	148.50 Box 12	140.00 Box 12
▽  <b>PS-2 (PC31)</b>	<b>#LV-497B</b>	3-0	3/8 Circle - <u>Prem</u> Reverse Cut	18" (45cm)	Undyed	J497G	148.50 Box 12	140.00 Box 12
	<b>#LV-496B</b>	4-0	3/8 Circle - <u>Prem</u> Reverse Cut	18" (45cm)	Undyed	J496G	148.50 Box 12	140.00 Box 12
	<b>#LV-495B</b>	5-0	3/8 Circle - <u>Prem</u> Reverse Cut	18" (45cm)	Undyed	J495G	148.50 Box 12	140.00 Box 12
○  <b>SH-1 (T14)</b>	<b>#LV-311B</b>	3-0	1/2 Circle - <u>Taper Point</u>	30" (76cm)	Violet	J311G	76.20 Box 12	70.90 Box 12
	<b>#LV-310B</b>	4-0	1/2 Circle - <u>Taper Point</u>	30" (76cm)	Violet	J310G	76.20 Box 12	70.90 Box 12

**SALVIN® SurgiPoint® PGA Polyglycolic Acid Synthetic Absorbable-Braided Fast Absorbing**



- Good Alternative To Plain Gut Sutures
- Synthetic Absorbable, Braided Coated Polyglycolic Acid – Similar To Vicryl Rapide™ But Greater Tensile Strength
- Unique PolyGlide Coating For Smooth No-Drag Suture Passage Through Tissue

**Resorbs In 7-14 Days**

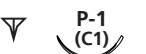
	Salvin Item#	Size	Needle	Length	Color	Vicryl™ Comparison	Per Box	10 Or More
▽  <b>FS-2 (C6)</b>	<b>#LVFA-493N</b>	3-0	3/8 Circle - Reverse Cutting	18" (45cm)	Undyed	VR497	100.10 Box 12	94.10 Box 12
	<b>#LVFA-423N</b>	3-0	3/8 Circle - Reverse Cutting	30" (76cm)	Undyed		100.10 Box 12	94.10 Box 12
	<b>#LVFA-492N</b>	4-0	3/8 Circle - Reverse Cutting	18" (45cm)	Undyed	VC422H	100.10 Box 12	94.10 Box 12
	<b>#LVFA-422N</b>	4-0	3/8 Circle - Reverse Cutting	30" (76cm)	Undyed	VR426	100.10 Box 12	94.10 Box 12
▽  <b>FS-1 (C7)</b>	<b>#LVFA-442N</b>	3-0	3/8 Circle - Reverse Cutting	30" (76cm)	Undyed	VR935	100.10 Box 12	94.10 Box 12
▽  <b>PS-2 (PC31)</b>	<b>#LVFA-497N</b>	3-0	3/8 Circle - <u>Prem</u> Reverse Cut	18" (45cm)	Undyed		100.10 Box 12	94.10 Box 12
	<b>#LVFA-496N</b>	4-0	3/8 Circle - <u>Prem</u> Reverse Cut	18" (45cm)	Undyed		100.10 Box 12	94.10 Box 12
▽  <b>P-1 (C1)</b>	<b>#LVFA-490C</b>	5-0	3/8 Circle - <u>Prem</u> Reverse Cut	18" (45cm)	Undyed		129.60 Box 12	119.40 Box 12

**More Sutures On Next 2 Pages** →



**SALVIN® SurgiPoint® Silk** Non-Resorbable



• Non-Resorbable, Braided, Coated Silk – Excellent Handling & Tying Characteristics

	Salvin Item#	Size	Needle	Length	Ethicon™ Comparison	Per Box	10 Or More
	<b>#L-770B</b>	2-0	3/8 Circle - Reverse Cutting	18" (45cm)	685-G	56.60 Box 12	52.70 Box 12
	<b>#L-784B</b>	3-0	3/8 Circle - Reverse Cutting	18" (45cm)	683G	56.60 Box 12	52.70 Box 12
	<b>#L-781B</b>	4-0	3/8 Circle - Reverse Cutting	18" (45cm)			
	<b>#L-754B</b>	5-0	3/8 Circle - Reverse Cutting	18" (45cm)			
	<b>#L-786B</b>	3-0	3/8 Circle - Reverse Cutting	18" (45cm)	684G	56.60 Box 12	52.70 Box 12
	<b>#L-787B</b>	4-0	3/8 Circle - Reverse Cutting	18" (45cm)	736G	56.60 Box 12	52.70 Box 12
	<b>#L-785B</b>	3-0	1/2 Circle - Reverse Cutting	18" (45cm)	632G	56.60 Box 12	52.70 Box 12

**SALVIN® SurgiPoint® Polypropylene** Non-Resorbable

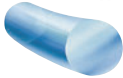

• Non-Resorbable Blue Monofilament – Inert, Easy To Handle, Passes Easily Through Tissue

	Salvin Item#	Size	Needle	Length	Ethicon™ Comparison	Per Box	10 Or More
	<b>#L-1085B</b>	5-0	3/8 Circle - <span style="color: blue;">Premium</span> Reverse Cutting	18" (45cm)	8698G	164.90 Box 12	153.60 Box 12
	<b>#L-1082B</b>	6-0	3/8 Circle - <span style="color: blue;">Premium</span> Reverse Cutting	18" (45cm)	8695G	164.90 Box 12	153.60 Box 12
	<b>#L-1079B</b>	6-0	3/8 Circle - <span style="color: blue;">Premium</span> Reverse Cutting	18" (45cm)	8697G	164.90 Box 12	153.60 Box 12
	<b>#L-2468N</b>	7-0	3/8 Circle - <span style="color: blue;">Premium</span> Reverse Cutting	18" (45cm)	8696G	164.90 Box 12	153.60 Box 12
	<b>#L-1011B</b>	6-0	3/8 Circle - Reverse Cutting	10" (25cm)	8889H	164.90 Box 12	153.60 Box 12
	<b>#L-8661B</b>	5-0	3/8 Circle - Reverse Cutting	18" (45cm)	8661G	84.90 Box 12	80.90 Box 12
	<b>#L-8680B</b>	5-0	3/8 Circle - Reverse Cutting	18" (45cm)	8680G	84.90 Box 12	80.90 Box 12

**SALVIN® SurgiPoint® Nylon Monofilament** Non-Resorbable



• Non-Resorbable Black Monofilament – Passes Easily Through Tissue – Similar To Resolon™

	Salvin Item#	Size	Needle	Length	Ethicon™ Comparison	Per Box	10 Or More
	<b>#L-922B</b>	4-0	3/8 Circle - Reverse Cutting	18" (45cm)	662G	65.90 Box 12	61.60 Box 12
	<b>#L-918B</b>	5-0	3/8 Circle - Reverse Cutting	18" (45cm)	661G	65.90 Box 12	61.60 Box 12
	<b>#L-698BKC</b>	5-0	3/8 Circle - <span style="color: black;">Black Premium</span> Reverse	18" (45cm)	698G	117.20 Box 12	111.70 Box 12
	<b>#L-1698B</b>	6-0	3/8 Circle - <span style="color: blue;">Premium</span> Reverse Cutting	18" (45cm)	1698G	117.20 Box 12	111.70 Box 12

**SALVIN® SurgiPoint® Polyviolene-Green Braided Polyester** Non-Resorbable



• Green Braided Uncoated Polyester – Smooth, Easy To Handle With Good Knot Security

	Salvin Item#	Size	Needle	Length	Ethicon™ Comparison	Per Box	10 Or More
	<b>#L-1180B</b>	4-0	3/8 Circle - Reverse Cutting	18" (45cm)	R683G	56.60 Box 12	52.70 Box 12

**SALVIN® SurgiPoint™ Chromic Gut** *Resorbs In 7-14 Days*



- Natural Resorbable Gut – Excellent Suture Except Where There Is Significant Tension Across The Wound

	Salvin Item#	Size	Needle	Length	Ethicon™ Comparison	Per Box	10 Or More
▽ <b>FS-2 (C6)</b> <small>MOST POPULAR</small>	#L-560B	3-0	3/8 Circle - Reverse Cutting	27" (68cm)	636G	56.70 Box 12	52.80 Box 12
	#L-559B	4-0	3/8 Circle - Reverse Cutting	27" (68cm)	635G	56.70 Box 12	52.80 Box 12
	#L-525B	3-0	3/8 Circle - Reverse Cutting	18" (45cm)		56.70 Box 12	52.80 Box 12
	#L-558B	4-0	3/8 Circle - Reverse Cutting	18" (45cm)		56.70 Box 12	52.80 Box 12
	#L-557B	5-0	3/8 Circle - Reverse Cutting	27" (68cm)		56.70 Box 12	52.80 Box 12
▽ <b>P-3 (C3)</b> <small>MOST POPULAR</small>	#L-595B	4-0	3/8 Circle - <u>Premium</u> Reverse Cutting	18" (45cm)	1654G	107.60 Box 12	101.60 Box 12
	#L-1248B	5-0	3/8 Circle - <u>Premium</u> Reverse Cutting	18" (45cm)	687G	107.60 Box 12	101.60 Box 12
▽ <b>P-1 (C1)</b>	#1242B-CP	6-0	3/8 Circle - <u>Premium</u> Reverse Cutting	18" (45cm)		180.30 Box 12	169.20 Box 12
⊙ <b>SH-1 (T4)</b>	#L-589B	4-0	1/2 Circle - <u>Taper Point</u> For Connective Tissue Grafts	14" (35cm)		69.40 Box 12	64.50 Box 12
⊙ <b>RB-1 (T28)</b>	#L-590B	5-0	1/2 Circle - <u>Taper Point</u> For Connective Tissue Grafts	14" (35cm)		56.70 Box 12	53.90 Box 12

**SALVIN® SurgiPoint™ Gut-Plain** *Resorbs In 5-10 Days*



- Natural Resorbable Gut – Excellent Suture Except Where There Is Significant Tension Across The Wound

	Salvin Item#	Size	Needle	Length	Ethicon™ Comparison	Per Box	10 Or More
▽ <b>FS-2 (C6)</b> <small>MOST POPULAR</small>	#L-554B	3-0	3/8 Circle - Reverse Cutting	27" (68cm)	H822G	56.70 Box 12	52.80 Box 12
	#L-551B	4-0	3/8 Circle - Reverse Cutting	27" (68cm)	H822G	56.70 Box 12	52.80 Box 12
	#L-591B	4-0	3/8 Circle - Reverse Cutting	18" (45cm)		56.70 Box 12	52.80 Box 12
	#L-592B	3-0	3/8 Circle - Reverse Cutting	18" (45cm)		56.70 Box 12	52.80 Box 12
▽ <b>P-3 (C3)</b>	#L-596B	5-0	3/8 Circle - <u>Premium</u> Reverse Cutting	18" (45cm)	686G	107.60 Box 12	101.60 Box 12
▽ <b>X-1 (C31)</b>	#L-594B	3-0	1/2 Circle - Reverse Cutting	18" (45cm)	612G	56.70 Box 12	52.80 Box 12
▽ <b>PC-1 (CP1)</b>	#L-1415B	6-0	3/8 Circle - <u>Premium</u> Reverse Cutting	18" (45cm)	1916G	182.30 Box 12	171.10 Box 12

**SALVIN® SurgiPoint™ Monoderm™** *Resorbs In 21-28 Days*



- Good Alternative To Chromic Gut Sutures
- Synthetic Resorbable Monofilament Glycolide & E-Caprolactone – Similar to Monocryl™

	Salvin Item#	Size	Needle	Length	Ethicon™ Comparison	Per Box	10 Or More
▽ <b>FS-2 (C6)</b>	#L-388	3-0	3/8 Circle - <u>Premium</u> Reverse Cutting	18" (45cm)		90.60 Box 12	82.50 Box 12
	#L-392C	4-0	3/8 Circle - <b>Black Premium</b> Reverse	18" (45cm)		90.60 Box 12	82.50 Box 12
▽ <b>FS-3 (C22)</b>	#L-395	4-0	3/8 Circle - <u>Premium</u> Reverse Cutting	18" (45cm)		90.60 Box 12	82.50 Box 12
▽ <b>PS-2 (DGL19)</b> <small>MOST POPULAR</small>	L-YD513N	4-0	3/8 Circle - <u>Premium</u> Reverse Cutting	18" (45cm)	Y513G	145.70 Box 12	137.70 Box 12
▽ <b>P-3 (C3)</b>	#L-464B	4-0	3/8 Circle - <u>Premium</u> Reverse Cutting	18" (45cm)		152.60 Box 12	144.40 Box 12
	#L-463B	5-0	3/8 Circle - <u>Premium</u> Reverse Cutting	18" (45cm)		152.60 Box 12	144.40 Box 12
	#L-463C	5-0	3/8 Circle - <b>Black Premium</b> Reverse	18" (45cm)	Y463G	152.60 Box 12	144.40 Box 12
	#L-492B	6-0	3/8 Circle - <u>Premium</u> Reverse Cutting	18" (45cm)		152.60 Box 12	144.40 Box 12
	<b>NEW!</b> #L-Q499B	6-0	3/8 Circle - <b>Violet Premium</b> Reverse	18" (45cm)		152.60 Box 12	144.40 Box 12

*Suture Names Are Trademarks Of Their Respective Companies.*

#1090 Salvin Split-Sheet Implant Pack



**MOST POPULAR**

#1090 Salvin Split-Sheet Pack

#1090 SOLD IN CASES OF 6  
 1 CASE . . . . . 455.70 CASE (75.95 EA)  
 2 CASES . . . . . 423.30 CASE (70.55 EA)

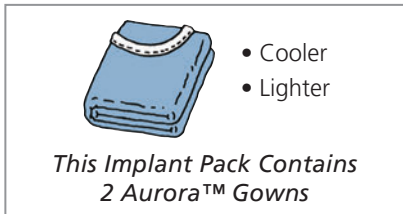

**BUYER'S GUIDE - SALVIN SPLIT-SHEET PACK**

- ▶ "Eyes Visible" Patient Drape
- ▶ One Pack With Two Separate Inner Wraps For Easier Set Up

**Doctor/Assistant Inner Wrap**

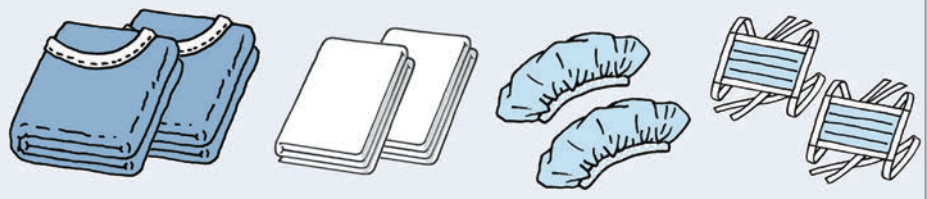

- 2 Large Operating Room Surgical Gowns
- 2 17" x 20" (38 x 51cm) Absorbent Towels
- 2 Bouffant Caps (Doctor & Assistant)
- 2 Face Masks With Ties
- Outer Wrapper Becomes 24" x 24" (61 x 61cm) Table Cover

**Patient / Room Setup Inner Wrap**

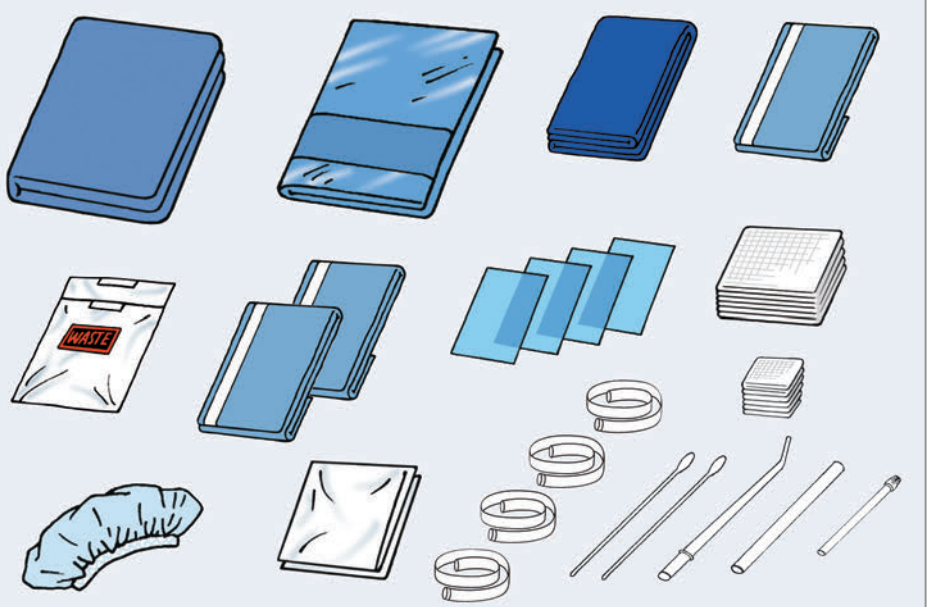

- 1 Implant "Split Sheet" Patient Drape 77" x 108" (195.5 x 274cm)
- 1 Bouffant Cap (For The Patient)
- 1 Cotton O/R Towel
- 1 Mayo Stand Or Back Table Cover
- 1 Oral Surgery Head Drape
- 2 18" x 24" (45.7 x 61cm) Utility Drapes With Tape
- 1 Machine or X-Ray Cover
- 4 4" x 6" (10 x 15.25cm) Light Handle/Chair Button Covers
- 4 Rapid Roll® Covers
- 1 Chairside Bag
- 2 6" (15.25cm) Cotton Tip Applicators
- 1 Surgical Aspirator Tip
- 1 Suction Tip With Out Slots
- 1 Saliva Ejector
- 25 Lint Free 2" x 2" (5 x 5cm) Sponges
- 8 Lint Free 4" x 4" (10 x 10cm) Sponges
- Outer Wrapper Becomes 45" x 45" (114 x 114cm) Table Cover

**Latexfree**

#1033 Salvin "Eyes Covered" Implant Pack

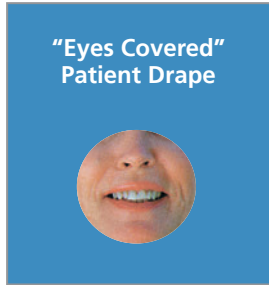

**MOST POPULAR**

#1033 Basic Implant Pack

#1033 SOLD IN CASES OF 6  
1 CASE . . . . . 450.00 CASE (75.00 EA)  
2 CASES . . . . . 419.10 CASE (69.85 EA)

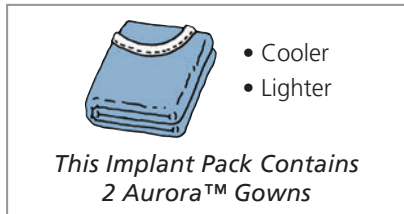

**Sterile Surgical Gloves**  
On Pages 44-45

**BUYER'S GUIDE - SALVIN "EYES COVERED" PACK**

- ▶ "Eyes Covered" Patient Drape
- ▶ **One Pack With Two Separate Inner Wraps For Easier Set Up**

**Doctor/Assistant Inner Wrap**

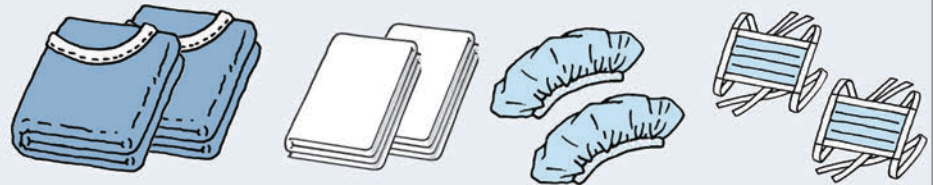

- 2 Large Operating Room Surgical Gowns
- 2 17" x 20" (38 x 51cm) Absorbent Towels
- 2 Bouffant Caps (Doctor & Assistant)
- 2 Face Masks With Ties
- Outer Wrapper Becomes 24" x 24" (61 x 61cm) Table Cover

**Patient / Room Setup Inner Wrap**

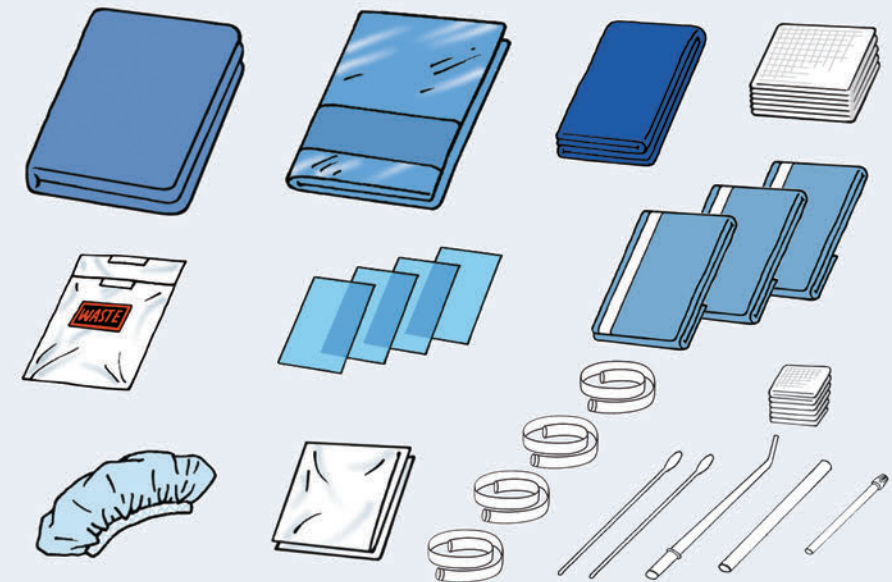

- 1 Implant Fenestrated Patient Drape 38 1/2" x 55" (97.5 x 139.5cm)
- 1 Bouffant Cap (For The Patient)
- 1 Cotton O/R Towel
- 1 Mayo Stand Or Back Table Cover
- 3 18" x 24" (45.7 x 61cm) Utility Drapes With Tape
- 1 Machine or X-Ray Cover
- 4 4" x 6" (10 x 15.25cm) Light Handle/Chair Button Covers
- 4 Rapid Roll® Covers
- 1 Chairside Bag
- 2 6" (15.25cm) Cotton Tipped Applicators
- 1 Surgical Aspirator Tip
- 1 Suction Tip With Out Slots
- 1 Saliva Ejector
- 25 Lint Free 2" x 2" (5 x 5cm) Sponges
- 8 Lint Free 4" x 4" (10 x 10cm) Sponges
- Outer Wrapper Becomes 45" x 45" (114 x 114cm) Table Cover

**Latexfree**



**Resnik Institute Implant Surgery Pack**

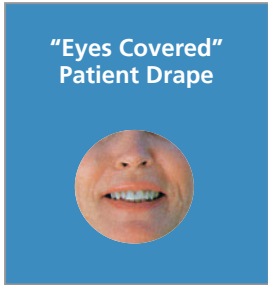

**Resnik Institute Implant Surgery Pack**

#RESNIK-PACK SOLD IN CASES OF 10  
 1 CASE . . . . . 404.00 CASE (40.40 EA)  
 2 CASES . . . . . 371.00 CASE (37.10 EA)

**BUYER'S GUIDE - RESNIK INSTITUTE PACK**

▶ "Eyes Covered" Patient Drape

**Resnik Institute Implant Surgery Pack**

- 1 Implant Fenestrated Patient Drape 38 1/2" x 55" (97.5 x 139.5cm)
- 5 Cotton O/R Towels
- 1 Chair Cover 41" x 85" (104 x 216cm)
- 1 Bouffant Cap
- 2 Rapid Roll® Covers
- 1 20" x 20" (50.8 x 50.8cm) CSR Wrap
- 2 30" x 30" (76.2 x 76.2cm) CSR Wraps
- 4 4" x 6" (10 x 15.25cm) Light Handle/ Chair Button Covers
- 2 Surgical Aspirator Tips
- 1 Suction Tip Without Slots
- 12 Lint Free 4" x 4" (10 x 10cm) Sponges
- 12 Lint Free 2" x 2" (5 x 5cm) Sponges
- Outer Wrapper Becomes 48" x 48" (121.9 x 121.9cm) Table Cover

**Latexfree**

**Salvin E.N.T. Head & Neck Pack**



**Salvin E.N.T. Head & Neck Pack**

#2000 SOLD IN CASES OF 8  
 1 CASE . . . . . 444.40 CASE (55.55 EA)  
 2 CASES . . . . . 409.60 CASE (51.20 EA)

**BUYER'S GUIDE - SALVIN E.N.T HEAD & NECK PACK**

▶ "Eyes Visible" Patient Drape

**Salvin E.N.T. Head & Neck Pack**

- 2 Large Operating Room Surgical Gowns
- 2 17" x 20" (38 x 51cm) Absorbent Towels
- 1 Implant "Split Sheet" Patient Drape 77" x 108" (195.5 x 274cm)
- 1 Oral Surgery Head Drape
- 1 Mayo Stand Or Back Table Cover
- 1 18" x 24" (45.7 x 61cm) Utility Drape With Tape
- 1 Chairside Bag
- Outer Wrapper Becomes 54" x 54" (137 x 137cm) Table Cover

**Latexfree**

- Cooler
- Lighter

*This Implant Pack Contains 2 Aurora™ Gowns*

## Salvin Perio/Minor Surgery Pack

### BUYER'S GUIDE - SALVIN PERIO/MINOR SURGERY PACK

#### Salvin Perio/Minor Surgery Pack

#1034 SOLD IN CASES OF 10  
 1 CASE . . . . . 344.00 CASE (34.40 EA)  
 2 CASES . . . . . 313.00 CASE (31.30 EA)



**Sterile Surgical Gloves**  
 On Pages 44-45

▶ This Pack Includes A Sterile Patient Bib

#### Salvin Perio/Minor Surgery Pack

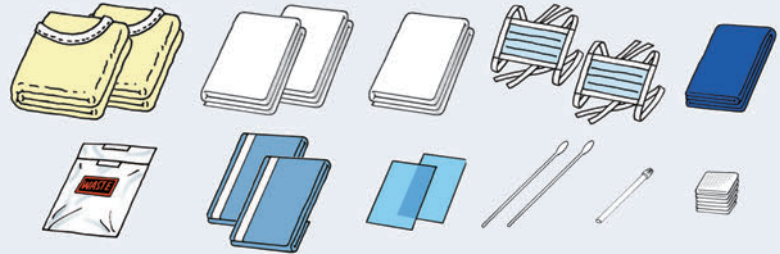

- 2 Yellow Isolation Gowns
- 2 17" x 20" (38 x 51cm) Absorbent Towels
- 1 18" x 36" (46 x 91cm) Patient Bib
- 2 Face Masks W/Ties
- 1 Cotton O/R Towel
- 1 Chairside Bag
- 2 18" x 24" (45.7 x 61cm) Utility Drapes With Tape
- 2 4" x 6" (10 x 15.25cm) Light Handle/ Chair Button Covers
- 2 6" (15.25cm) Cotton Tipped Applicators
- 1 Suction Tip Without Slots
- 1 Saliva Ejector
- 25 Lint Free 2" x 2" (5 x 5cm) Sponges
- Outer Wrapper Becomes 36" x 36" (91 x 91cm) Table Cover

**Latexfree**

## Individual Sterile Patient Drapes

**MOST POPULAR**

#### Split Sheet "Eyes Visible" Sterile Patient Drape

**Latexfree**

- Individually Packaged
- 77" x 108" (195.5 x 274cm)

#DRAPE-SPLIT SHEET  
 CASE OF 24 . . . . . 480.00 CASE  
 2 OR MORE CASES . . . . . 448.70 CASE

#### Patient Drape Detail



#DRAPE-SPLIT SHEET

#### Drape 33 "Eyes Covered" Sterile Patient Drape

**Latexfree**

- Individually Packaged
- 38 1/2" x 55" (97.5 x 139.5cm)

#DRAPE33  
 CASE OF 24 . . . . . 415.00 CASE  
 2 OR MORE CASES . . . . . 394.30 CASE

#### Patient Drape Detail

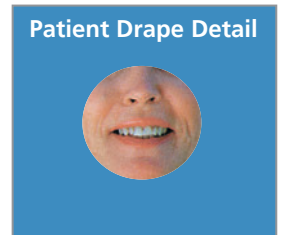

#DRAPE 33

## Rapid Roll® Covers & Sterile Drapes

### SALVIN Rapid Roll®

**MOST POPULAR**

- Individually Packaged
- 65" (165cm) Long

#RAPID-ROLL  
 BOX OF 25 . . . . . 113.80 BOX  
 2 OR MORE BOXES . . . . . 105.50 BOX



**Latexfree**

Scan For

60<sup>o</sup> Second Product Video™



Scan For

60<sup>o</sup> Second Product Video™



#### Sterile Drapes

- Individually Packaged Poly Lined Paper Drape
- 18" x 26" (45.7 x 66cm)
- Use As Patient Bib, Table Cover, Etc.

#TOWEL-DRAPE-50  
 BOX OF 50 . . . . . 56.70 BOX  
 2 OR MORE BOXES . . . . . 54.30 BOX



**Latexfree**

**Salvin Sterile Gown/Towel Packs**



**Latexfree**



**Salvin Sterile Gown / Towel Pack - UNISIZE Fit Gown**

- 1 Sterile O/R Gown (Large-XLarge Fit)
- 1 Absorbent Scrub Towel 15" x 30" (38 x 76cm)

#1001

CASE OF 24 ..... 477.00 CASE  
2 OR MORE CASES ..... 463.20 CASE

**Salvin Sterile Gown / Towel Pack - SMALL Size Gown**

- 1 Sterile O/R Gown (Small-Medium Fit)
- 1 Absorbent Scrub Towel 15" x 30" (38 x 76cm)

#GOWN-SMALL

CASE OF 30 ..... 399.70 CASE  
2 OR MORE CASES ..... 385.20 CASE

**Sterile Absorbent Scrub Towels**

- 80 Individually Packaged Absorbent Scrub Towels 15" x 30" (38 x 76cm)

#TOWEL-SCRUB-80

CASE OF 80 ..... 157.90 CASE  
2 OR MORE CASES ..... 149.70 CASE

**Backhaus Towel Clamp**

- Sharp Points
- Use For Cloth Drapes

#BACKHAUS ..... 21.20 EACH  
3 OR MORE ..... 19.30 EACH



- Aurora™ Gown**
- More Protection
  - Cooler
  - Lighter

**O/R & Isolation Gowns – Non-Sterile**



**Latexfree**



- Aurora™ Gown**
- More Protection
  - Cooler
  - Lighter



**Latexfree**



**Latexfree**

**MOST POPULAR**

**Disposable Blue O/R Gown (Non-Sterile)**

- The Feel Of Cotton Without The Weight
- Breathable Gown With Knitted Cuffs
- Tie Back & Velcro Neck Closure
- Generously Sized Unisize Fit

#OR-GOWN

CASE OF 50 ..... 440.00 CASE  
2 OR MORE CASES ..... 416.40 CASE

**Trauma Isolation Gown-White (Non-Sterile)**

- Knitted Cuffs For Comfort
- Totally Impervious Yet Breathable
- Unisize Fit

#ISO-TRAUMA-GOWN-XL

CASE OF 50 ..... 341.00 CASE  
2 OR MORE CASES ..... 324.90 CASE

**Isolation Gown-Yellow (Non-Sterile)**

- Elastic Cuff
- Unisize Fit

#ISO-GOWN-50

CASE OF 50 ..... 102.50 CASE  
2 OR MORE CASES ..... 96.10 CASE

## Surgical N95 Respirator

- Flat Pouched Design Provides A Cooler Breathing Chamber
- Non-Abrasive Comfort Layer For Moisture Management

### Surgical N95 Respirator

- Approved For Use By The FDA And NIOSH
- ASTM F1862 Level 3 Fluid Resistance
- Sold In Boxes Of 50

#N95-MASK-50 .....73.50 BOX OF 50



## Towels, Caps & Shoe Covers



Latexfree

### Surgeon's Caps

#SURG CAP 100  
BOX OF 100 ..... 38.50 BOX  
2 OR MORE BOXES .....35.40 BOX



Latexfree

**MOST POPULAR**

### Bouffant Caps

#BOUF CAP 100  
BOX OF 100 .....33.70 BOX  
2 OR MORE BOXES ..... 30.90 BOX



Latexfree

### Blue 100% Cotton O/R Towels

16" x 27" (40.6 x 68.6cm)  
Single Use  
#OR TOWEL 50  
CASE OF 50 .....127.90 CASE  
2 OR MORE CASES ..... 122.70 CASE

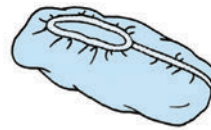

Latexfree

### Shoe Covers-Unisize

- Fits Over Regular Shoes
- No-Slip Grip On Bottom For Safety In The Office

#SHOE 100  
BOX OF 100 .....41.40 BOX  
2 OR MORE BOXES .....38.60 BOX

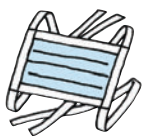

Latexfree

### Surgical Masks W/Ties

Soft Polypropylene Facing For Comfort & Protection  
#SURG-MASK-TIE  
BOX OF 50 .....24.80 BOX  
6 OR MORE BOXES .....22.20 BOX

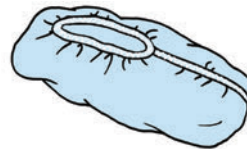

Latexfree

**MOST POPULAR**

### Shoe Covers-Sport

- Fits Over Athletic Shoes
- No-Slip Grip On Bottom For Safety In The Office

#SHOE-SPORT-100  
BOX OF 100 .....46.90 BOX  
2 OR MORE BOXES ..... 44.20 BOX

## Patient Skin Prep

### ChloraPrep® Surgical Skin Prep Individual Swabs

- Chlorhexidine Gluconate/IPA
- Effective Skin Antiseptic
- Will Not Stain Or Irritate Skin
- Rapid Action Against Microorganisms
- Available In US Only

#CHLORA-PREP  
BOX OF 20 ..... 59.90 BOX  
2 BOXES ..... 56.50 BOX



Latexfree

**MOST POPULAR**

### Patient Prep Individual Swab Sticks

Povidone Iodine (Iodophor)  
#SWABSTICK 50  
BOX OF 50 ..... 21.90 BOX  
2 BOXES ..... 19.90 BOX



Latexfree



**Cold Therapy**



Plastic Outer Covering

**Latexfree**



"Sweatless" Covering For Comfort

**Latexfree**



**Latexfree**

**MOST POPULAR**

**Instant Cold Pack**

- Squeeze To Activate
- 6" x 8.75" (15.2 x 22.2cm)

#INSTANT-COLD

BOX OF 24 .....50.20 BOX  
2 OR MORE BOXES .....46.70 BOX

**Deluxe Instant Cold Pack**

- Squeeze To Activate
- 6.75" x 9" (17.1cm x 22.86cm)

#INSTANT-COLD-DELUXE

BOX OF 24 .....71.90 BOX  
2 OR MORE BOXES .....65.70 BOX

**Bilateral Ice Pack**

- No Wetness Or Leakage
- Refillable Ice Pack With Velcro Strap

#BILAT-24

CASE OF 24 ..... 220.50 CASE  
2 OR MORE CASES ..... 211.60 CASE

**Sterillium Rub® Surgical Hand Scrub**

- Exceeds FDA Requirements For Surgical Hand Antisepsis
- 80% Ethanol For Superior Germ Killing
- Chlorhexidine Gluconate (CHG) Free To Prevent Hand Irritation



**Touchless Activation Dispenser**

- Mount With Screws (Included) Or Double-Sided Tape
- Uses 4 "D" Batteries (Not Included)

#SCRUB-STERI-DISPENSE .....172.90 EACH



**Sterillium® Rub Surgical Hand Scrub Refills**

- Approximately 850 Uses Per Bottle
- Fits Touchless Dispenser On This Page

#SCRUB-STERI-1000. .... 237.90 PKG OF 2

**SPECIAL**



**Sterillium® Starter Kit**

Includes:

- Touchless Activation Dispenser
- 2 1000mL Bottles

#SCRUB-STERI-KIT  
**353.00 COMPLETE KIT**

2 OR MORE STARTER KITS  
**325.00 COMPLETE KIT**

**Scrub Brushes**

**Iodophor Surgical Scrub Brush / Sponge**

Traditional Hospital Iodine Based Iodophor Solution

#SCRUB-POV-30

BOX OF 30 ..... 65.90 BOX  
2 BOXES ..... 62.40 BOX



**MOST POPULAR**

**"Clens" Type Surgical Scrub Brush / Sponge**

PCMX "Clens" Solution Is Kinder To Sensitive Hands

#SCRUB-CLEN-30

BOX OF 30 ..... 71.60 BOX  
2 BOXES ..... 67.40 BOX



### Sterile Equipment Covers

#### Sterile "Self Stick" **MOST POPULAR** Light Handle Covers

- 20cm x 20cm
- Packaged Sterile In Sets Of 2 (50 Sets Per Case)



#LIGHT-HANDLE-COVER

1 CASE . . . . . 185.90 CASE  
2 OR MORE CASES . . . . . 177.30 CASE

#### Sterile Mayo Stand Cover

- Individually Packaged
- Fits Regular Mayo Stands
- 24" x 24" (61 x 61cm)



#MAYO-COVER

CASE OF 24 . . . . . 305.00 CASE  
2 OR MORE CASES . . . . . 296.40 CASE

**Latexfree**

#### Sterile Machine Or X-Ray Cover

- Individual Sterile Machine Cover For X-Ray Cassette, Arm Rest, Implant Motor, Etc.



- 24" x 40" (61 x 101.6cm)

#MACHINE-COVER-50

CASE OF 50 . . . . . 209.50 CASE  
2 OR MORE CASES . . . . . 200.40 CASE

**Latexfree**

#### Sterile Surgical Table Cover

- Individually Packaged
- Fits Surgical Tables
- 53" x 77" (134 x 195cm)



#SURG-TABLE-COVER

CASE OF 20 . . . . . 106.70 CASE  
2 OR MORE CASES . . . . . 99.40 CASE

**Latexfree**

### Sterilization Wrap For Surgical Kits & Steam Autoclave Tape



#### 18" x 18" Sterilization Wrap

45.7cm x 45.7cm

#INST-WRAP-18 . . . . . 248.30 CASE OF 1000

**Latexfree**

**MOST POPULAR**

#### 24" x 24" Sterilization Wrap

61cm x 61cm

#INST-WRAP-24 . . . . . 184.90 CASE OF 500

**Latexfree**



#### Steam Autoclave Tape - 1" x 60 YDS

- Changes From Beige To Black To Indicate Proper Sterilization Cycle

#CLAVE-TAPE-1X60 . . . . . 11.30 ROLL  
5 OR MORE . . . . . 9.70 ROLL

**Latexfree**

### Instrument Cleaners



#### EZ-Zyme Enzyme Instrument Cleaner

- Concentrated - 1 Packet Makes A Gallon
- Dissolves Blood & Tissue
- Instrument Pre-Soak
- Ultrasonic & Evac System Cleaner
- Biodegradable & Neutral PH

#EZ-ZYME

BOX OF 32 PACKETS . . . . . 92.70 BOX  
2 OR MORE . . . . . 86.80 BOX

**MOST POPULAR**

#### Surgical Instrument Spray Lubricant - 8 oz.

"Instrument Milk" In A Spray

- For Hinged Instruments
- Keeps Scissors Sharp
- Preserves Instrument Life
- Non-Greasy, Anti-Corrosive

#SPRAY LUBE . . . . . 17.20 EACH  
2 OR MORE . . . . . 15.30 EACH



#### Instrument Stain Remover

- Removes Stains & Tarnish
- Will Not Harm Instrument Surfaces

#STAIN . . . . . 17.20 EACH  
2 OR MORE . . . . . 15.30 EACH

**Stainless Steel Instrument Cassettes**



**MOST POPULAR**

**8 Instrument Stainless Steel Cassette**

- Silicone Cushions & Locking Crossbar
  - 7.3" x 5.2" x 0.9" (18.5 x 13.3 x 2.3cm)
- #CASS-SS-8 ..... 179.60 EACH  
 3 OR MORE ..... 171.50 EACH

**MOST POPULAR**

**16 Instrument Stainless Steel Cassette**

- Silicone Cushions & Locking Crossbar
  - 10.7" x 7.3" x 0.9" (27.3 x 18.5 x 2.3cm)
- #CASS-SS-16 ..... 214.30 EACH  
 3 OR MORE ..... 203.50 EACH

**Plastic Instrument Cassettes**

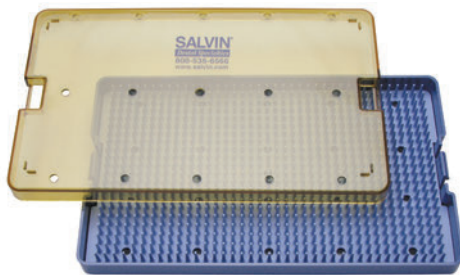

**10" x 6" Cassette**

- "Finger Tip" Mat
  - Autoclave, Dry Heat, Chemical Sterilization
  - 25cm x 15.3cm - 0.75" (1.9cm) Height
- #CASSETTE-10X6 ..... 132.90 EACH  
 3 OR MORE ..... 127.10 EACH



*Ideal For Large Instruments*

**MOST POPULAR**

**10" x 6" Deep Cassette**

- "Finger Tip" Mats
  - Autoclave, Dry Heat, Chemical Sterilization
  - 25cm x 15.3cm - 1.5" (3.7cm) Height
- #CASSETTE-DEEP-BASE ..... 158.90 EACH  
 3 OR MORE ..... 149.80 EACH

**Sterilization Pouches For Instrument Cassettes**



**12" x 15" Self-Sealing Instrument Cassette Sterilization Pouches**

- Fits All Salvin Instrument Cassettes
  - Fits Other Brand Cassettes Up To 8" x 12" (20.3cm x 30.5cm)
  - External & Internal Indicators With See-Through Packaging For Visibility
- #POUCH-12X15-STER ..... 114.80 BOX OF 200  
 2 OR MORE ..... 109.30 BOX OF 200

**Latexfree**



Salvin "Where Is It?" Small Parts Cassettes

Perfect For Busy Practices – No More Looking For Small Parts!



For Larger Parts



For Smaller Parts



"Where Is It?" Stainless Steel Cassette - Large

- 7.1cm Wide x 5.3cm Deep x 2.3cm Tall

#WHERE-IS-IT-LARGE . . . . . 46.10 EACH  
3 OR MORE . . . . . 42.50 EACH

**MOST POPULAR**

"Where Is It?" Stainless Steel Cassette - Small

- 7.1cm Wide x 3.7cm Deep x 1.4cm Tall

#WHERE-IS-IT-SMALL . . . . . 38.60 EACH  
3 OR MORE . . . . . 36.10 EACH

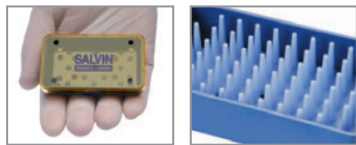

Includes Removable Silicone Mat



**MOST POPULAR**

"Where Is It?" - Plastic Cassette

- Removable "Finger Tip" Mat
- 7.3cm Wide x 4cm Deep x 1.9cm Tall

#WHERE-IS-IT-PLASTIC . . . . . 29.70 EACH  
3 OR MORE . . . . . 27.40 EACH

**SPECIAL**

Set Of 3 Salvin "Where Is It?" Cassettes



#WHERE-IS-IT-SET-3 . . . . . **85.60 SET**

Small Parts Organizing System

- One 10" x 6" Deep Cassette & Nine "Where-Is-It" Plastic Cassettes
- Autoclave, Dry Heat, Chemical Sterilization

#CASS-ORG-KIT . . . . . 376.00 SET



Bur Blocks On Page 61



**SURGICAL GLOVE BUYER'S GUIDE**



**The FDA Is Moving Towards Eliminating Powdered Gloves.**

All Gloves On These Pages Are Powder Free, Easy To Don, & Provide Excellent Tactile Sensitivity.

**Anatomically Shaped Gloves Are Curved To Fit Both Right & Left Hands.**

Unlike Flat "Cookie Cutter" Exam Gloves, These Flex Without Stretching To Prevent Cramping & Fatigue.

Glove Size Chart			
Extra Small	5.5	Large	7.5 - 8.0
Small	6.0	Extra Large	8.5
Medium	6.5 - 7.0	Extra Extra Large	9.0

**Signature™ Latex Essential Surgical Gloves**



**Synthetic Polymer Coating For Exceptional Damp Hand Donning**

- Beaded Cuff For Easy Donning Without Roll-Back
- Proprietary Coating For Easy Damp/Dry Donning

Glove Guide	
	<b>Powder Free</b>
	<b>Anatomically Shaped</b>
	<b>Sterile</b>
	<b>Latex</b>

Size	Product Number	
6	#GL-MSG-5960	
6 1/2	#GL-MSG-5965	
7	#GL-MSG-5970	
7 1/2	#GL-MSG-5975	
8	#GL-MSG-5980	BOX OF 50 PAIRS . . . . . 127.90 BOX
8 1/2	#GL-MSG-5985	2 OR MORE BOXES . . . . . 120.60 BOX

**See For Yourself! Please Call For Samples Of Any Of Our Gloves**

SensiCare® - Synthetic Surgical Gloves

**MOST POPULAR**



*Fit & Feel Of Latex But Without The Latex Proteins & Allergens*

*Pure Aloe Vera Coating* Is Applied To Interior Glove Surface. Body Heat Activates The Aloe, Coating & Protecting Your Hands.

- Beaded Cuff For Easy Donning Without Roll-Back
- Unique Styrene-Isoprene-Styrene (SIS) Synthetic
- Proprietary Coating For Easy Damp/Dry Donning
- Bisque Finish For A Better Grip

Glove Guide	
▶	Powder Free
▶	Anatomically Shaped
▶	Sterile
▶	Latex Free Synthetic
▶	Aloe Vera

Size	Product Number	
6	#GL-MDS-377060	
6 1/2	#GL-MDS-377065	
7	#GL-MDS-377070	
7 1/2	#GL-MDS-377075	
8	#GL-MDS-377080	BOX OF 25 PAIRS . . . . . 129.40 BOX
8 1/2	#GL-MDS-377085	2 OR MORE BOXES . . . . . 122.10 BOX

SensiCare® PI Micro - Synthetic Surgical Gloves



*15% Thinner Than Standard Gloves To Enhance Tactile Sensitivity*

- Beaded Cuff For Easy Donning Without Roll-Back
- Proprietary Coating For Easy Damp/Dry Donning

Glove Guide	
▶	Powder Free
▶	Anatomically Shaped
▶	Sterile
▶	Latex Free Synthetic

Size	Product Number	
6	#GL-MSG-9660	
6 1/2	#GL-MSG-9665	
7	#GL-MSG-9670	
7 1/2	#GL-MSG-9675	
8	#GL-MSG-9680	BOX OF 50 PAIRS . . . . . 225.60 BOX
8 1/2	#GL-MSG-9685	2 OR MORE BOXES . . . . . 215.10 BOX

*See For Yourself! Please Call For Samples Of Any Of Our Gloves*

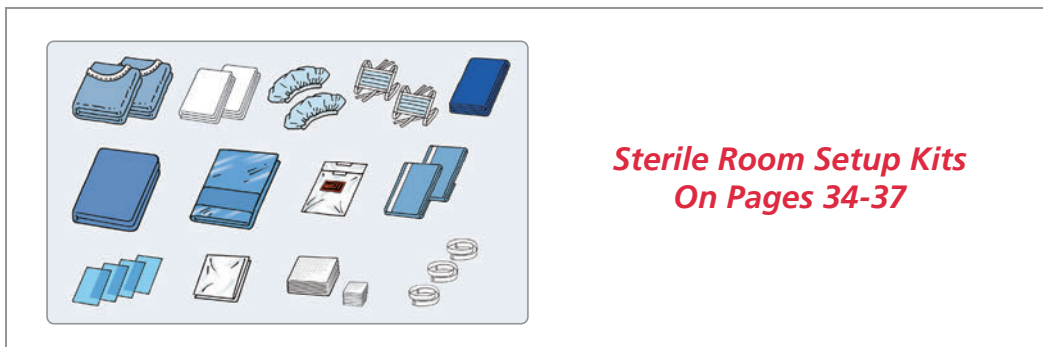

*Sterile Room Setup Kits  
On Pages 34-37*

# Piezotome Cube

Safely Cuts Bone While Preserving Soft Tissue



*Power Adjusts Dynamically For Effortless Cuts  
Will Not Damage Soft Tissue*

Automatically  
Reduces Power  
In Softer Bone

Automatically  
Increases Power  
In Denser Bone



### BUYER'S GUIDE

- ▶ Console With Irrigation
- ▶ LED Piezo Handpiece
- ▶ Touch Screen Display

### PROCEDURE GUIDE

- ▶ Atraumatic Extractions
- ▶ Block Grafting
- ▶ Osteoplasty
- ▶ Lateral Sinus Lift
- ▶ Crestal Sinus Lift
- ▶ Ridge Splitting
- ▶ Osteotomies
- ▶ Crown Lengthening

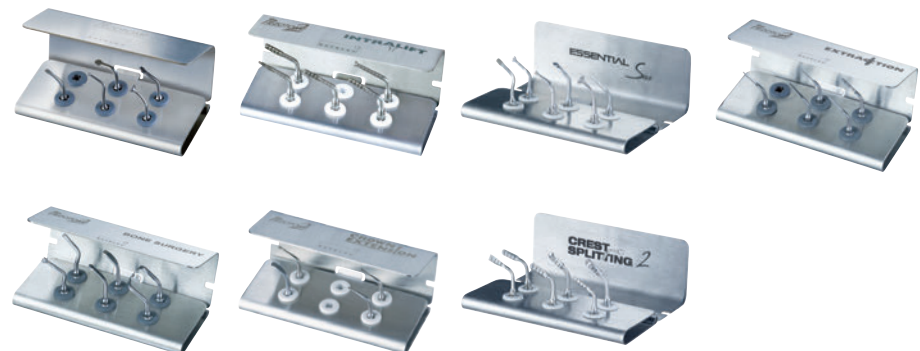

*Call For Package Specials*



"There is nothing like the Piezotome for lifting the sinus membrane, harvesting autogenous bone & removing lingual tori while protecting the soft tissue in the floor of the mouth."

**-Dr. John Russo**  
Periodontist, Sarasota, FL



"The use of the Piezotome has been the most revolutionary development in extractions in my career. Most extractions are completed in a matter of minutes with NO loss of alveolar bone."

**-Dr. Michael Sonick**  
Periodontist, Fairfield, CT

## Implant Center 2



**Piezotome + Implant Motor  
Combination**

Scan For  
**60<sup>+</sup> Second  
Product  
Video™**



*Motor Fits Your Existing Implant Handpieces  
Cuts Bone While Preserving Soft Tissue  
LED Handpiece For Excellent Visibility  
60 Watts Of Power For Faster Cuts*

BUYER'S GUIDE	
▶ Console With Irrigation	▶ LED Implant Handpiece
▶ LED Piezo Handpiece	▶ 100 to 40,000 RPM
▶ Touch Screen Display	

PROCEDURE GUIDE	
▶ Implant Placement	
▶ Atraumatic Extractions	
▶ Block Grafting	
▶ Osteoplasty	
▶ Lateral Sinus Lift	
▶ Crestal Sinus Lift	
▶ Ridge Splitting	
▶ Osteotomies	
▶ Crown Lengthening	

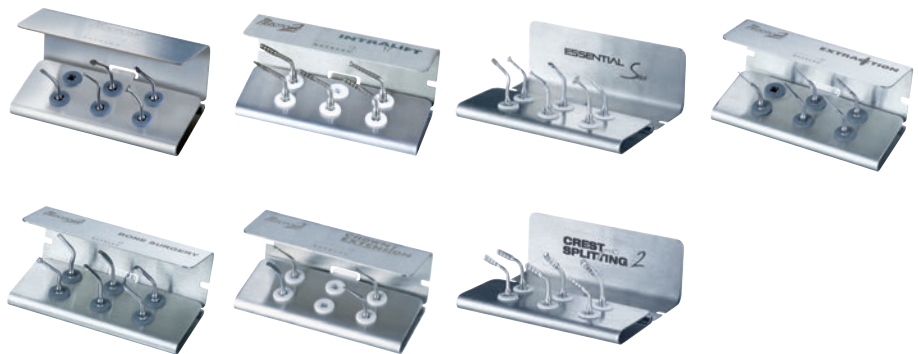

*Call For Package Specials*

## Piezotome Accessories



### Autoclavable Tubing With Pump

Includes 10 Disposable Spikes

#PIEZO-IRR-AC . . . . . 193.00 EACH

### Disposable Irrigation Spikes

Pkg Of 10 Spikes

#PIEZO-IRR-SPIKE . . . . . 57.00 PKG OF 10



*Salvin Surgical  
Cart On Page 150*

*Tips Shown By Procedure On Next Two Pages* →



**Atraumatic Extraction Kit** *MOST POPULAR*

For Piezotome 2 or Cube  
 #PIEZO-2-EXTRACTION-KIT  
 WITH CASSETTE. . . . . 1680.00 KIT

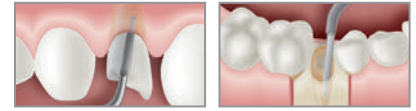

	LC1 Tip	LC2 Tip	LC2L Tip	LC2R Tip	Ninja Tip
<b>Piezotome 2 or Cube</b>	#PIEZO2-TIP-LC1	#PIEZO2-TIP-LC2	#PIEZO2-TIP-LC2L	#PIEZO2-TIP-LC2R	#PIEZO2-TIP-NINJA
	294.00 EACH	294.00 EACH	294.00 EACH	294.00 EACH	294.00 EACH

**Sinus Lift Kit** *MOST POPULAR*

For Piezotome 2 or Cube  
 #PIEZO-2-SL-TIP-KIT  
 WITH CASSETTE. . . . . 1400.00 KIT



	SL1 Diamond Tip	SL2 Diamond Tip	SL3 Tip	SL4 Tip	SL5 Tip
<b>Piezotome 2 or Cube</b>	#PIEZO2-TIP-SL1	#PIEZO2-TIP-SL2	#PIEZO2-TIP-SL3	#PIEZO2-TIP-SL4	#PIEZO2-TIP-SL5
	294.00 EACH	294.00 EACH	294.00 EACH	294.00 EACH	294.00 EACH

**Bone Surgery Kit**

For Piezotome 2 or Cube  
 #PIEZO-2-BS-TIP-KIT  
 WITH CASSETTE. . . . . 1680.00 KIT

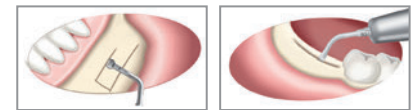

	BS1-Slim Tip	BS2L Tip	BS2R Tip	BS4 Tip	BS5 Tip	BS6 Tip
<b>Piezotome 2 or Cube</b>	#PIEZO2-TIP-BS1-SLIM	#PIEZO2-TIP-BS2L	#PIEZO2-TIP-BS2R	#PIEZO2-TIP-BS4	#PIEZO2-TIP-BS5	#PIEZO2-TIP-BS6
	294.00 EACH	294.00 EACH	294.00 EACH	294.00 EACH	294.00 EACH	294.00 EACH

Essential Kit

For Piezotome 2 or Cube

#PIEZO2-ESSENTIAL-KIT

WITH CASSETTE. . . . . 1680.00 KIT

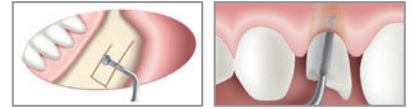

<b>Piezotome 2 or Cube</b>	<b>BS1-Slim Tip</b>	<b>BS4 Tip</b>	<b>SL1 Diamond Tip</b>	<b>SL2 Diamond Tip</b>	<b>SL3 Tip</b>	<b>LC2 Tip</b>
#PIEZO2-TIP-BS1-SLIM	#PIEZO2-TIP-BS4	#PIEZO2-TIP-SL1	#PIEZO2-TIP-SL2	#PIEZO2-TIP-SL3	#PIEZO2-TIP-LC2	
294.00 EACH	294.00 EACH	294.00 EACH	294.00 EACH	294.00 EACH	294.00 EACH	294.00 EACH

Crest Splitting Kit **MOST POPULAR**

For Piezotome 2 or Cube

#PIEZO-2-CS-TIP-KIT

WITH CASSETTE. . . . . 1680.00 KIT



<b>Piezotome 2 or Cube</b>	<b>CS1 Tip</b>	<b>CS2 Tip</b>	<b>CS3 Tip</b>	<b>CS4 Tip</b>	<b>CS5 Tip</b>	<b>CS6 Tip</b>
#PIEZO2-TIP-CS1	#PIEZO2-TIP-CS2	#PIEZO2-TIP-CS3	#PIEZO2-TIP-CS4	#PIEZO2-TIP-CS5	#PIEZO2-TIP-CS6	
294.00 EACH	294.00 EACH	294.00 EACH	294.00 EACH	294.00 EACH	294.00 EACH	294.00 EACH

Osteotomy Kit

For Piezotome 2 or Cube

#PIEZO-2-INTRALIFT-KIT

WITH CASSETTE. . . . . 1400.00 KIT



<b>Piezotome 2 or Cube</b>	<b>TKW1 Tip</b>	<b>TKW2 Tip</b>	<b>TKW3 Tip</b>	<b>TKW4 Tip</b>	<b>TKW5 Tip</b>
#PIEZO2-TIP-TKW1	#PIEZO2-TIP-TKW2	#PIEZO2-TIP-TKW3	#PIEZO2-TIP-TKW4	#PIEZO2-TIP-TKW5	
294.00 EACH	294.00 EACH	294.00 EACH	294.00 EACH	294.00 EACH	294.00 EACH

Crown Lengthening Kit

For Piezotome 2 or Cube

#PIEZO-2-CE-TIP-KIT

WITH CASSETTE. . . . . 1125.00 KIT



<b>Piezotome 2 or Cube</b>	<b>CE1 Tip</b>	<b>CE2 Tip</b>	<b>CE3 Tip</b>	<b>BS6 Tip</b>
#PIEZO2-TIP-CE1	#PIEZO2-TIP-CE2	#PIEZO2-TIP-CE3	#PIEZO2-TIP-BS6	
294.00 EACH	294.00 EACH	294.00 EACH	294.00 EACH	

For Accelerated  
Orthodontic  
Bone Cuts



Rounded Piezo Tip

#PIEZO2-TIP-BS1-ROUND
294.00 EACH

Implant & Oral Surgery Handpieces



**32:1 Reduction Push Button Latch Contra Angle**

FOR DRILLING, TAPPING & PLACEMENT  
RECOMMENDED SPEED FOR MOST IMPLANT SYSTEMS

- 10 To 1,000 RPM For Drilling, Tapping & Placement
- Internal & External Irrigation
- Autoclave Or Chemiclave Up To 275° F (135° C)

#NOU-32-1 . . . . . 1035.00 EACH



**16:1 Reduction Push Button Latch Contra Angle**

ORDER THIS HANDPIECE FOR IMPLANT SYSTEMS  
REQUIRING DRILLING SPEEDS EXCEEDING 1,250 RPM

- 20 To 2,400 RPM For Drilling & Placement
- Internal & External Irrigation
- Autoclave Or Chemiclave Up To 275° F (135° C)

#NOU-16-1 . . . . . 1035.00 EACH



**MOST POPULAR**

**20:1 Reduction Push Button Latch Contra Angle**

- 15 To 1,700 RPM
- Internal & External Irrigation
- Autoclave Or Chemiclave Up To 275° F (135° C)
- Works With X-Guide

#NOU-20-1 . . . . . 1135.00 EACH



**MOST POPULAR**

**1:1 40,000 RPM Straight Surgical**

For Bone & Jaw Surgery

- 300 To 40,000 RPM
- External Irrigation
- Autoclave Or Chemiclave Up To 275° F (135° C)

#NOU-1-1-STRAIGHT . . . . . 1019.00 EACH



**1:1 40,000 RPM Angled Surgical**

For Bone & Jaw Surgery

- 300 To 40,000 RPM
- External Irrigation
- Autoclave Or Chemiclave Up To 275° F (135° C)

#NOU-1-1-ANGLED . . . . . 1135.00 EACH

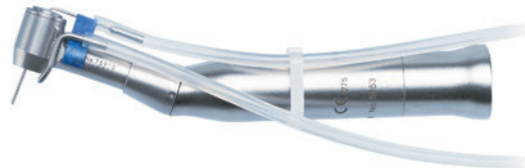

**1:1 Push Button Latch Contra Angle**

- 300 To 40,000 RPM
- Internal & External Irrigation
- Autoclave Or Chemiclave Up To 275° F (135° C)

#NOU-1-1-LATCH . . . . . 750.00 EACH



**1:2 Straight Surgical (Multiplies RPM X 2)**

For Bone & Jaw Surgery

- 1,000 To 80,000 RPM
- External Irrigation
- Autoclave Or Chemiclave Up To 275° F (135° C)

#NSK-1-2-HANDPIECE . . . . . 1400.00 EACH

*Handpieces On This Page Fit All Standard "E" Type Implant Motors*

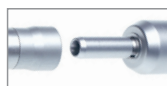

*Autoclavable Handpiece Lubricant & Cleaning Spray On Page 53*



Salvin Motor Systems For Implantology & Oral Surgery



**Single Motor System**



**BUYER'S GUIDE - IMPLANT MOTORS**

▶	One Motor Unit
▶	300 to 40,000 RPM Brushless Motor
▶	Pre-Selectable Torque Levels 10 -- 70Ncm
▶	Memory Backup For Program Changes
▶	Autoclavable Motor & Cord
▶	Internal & External Irrigation Pump

**SPECIAL**

**Single Motor – 1 Handpiece Package**

**Includes:**  
Single Motor Console & 1 Motor, 1 Handpiece

**MOST POPULAR**

**With 20:1 Handpiece (25 To 2,000 RPM)**  
#MOTOR-SINGLE-20-1..... **5140.00**

**With 32:1 Handpiece (15 To 1,250 RPM)**  
#MOTOR-SINGLE-32-1..... **5140.00**

**With 16:1 Handpiece (30 to 2,500 RPM)**  
#MOTOR-SINGLE-16-1..... **5140.00**

**Dual Motor System**



**BUYER'S GUIDE - IMPLANT MOTORS**

▶	Two Motor Unit
▶	300 to 50,000 RPM Brushless Motor
▶	Pre-Selectable Torque Levels 10 -- 70Ncm
▶	Memory Backup For Program Changes
▶	Autoclavable Motor & Cord
▶	Internal & External Irrigation Pump

**SPECIAL**

**Dual Motor – 1 Handpiece Package**

**Includes:**  
Dual Motor Console & 2 Motor, 1 Handpiece

**With 20:1 Handpiece (25 To 2,500 RPM)**  
#MOTOR-DUAL-20-1..... **6470.00**

**With 32:1 Handpiece (15 To 1,550 RPM)**  
#MOTOR-DUAL-32-1..... **6470.00**

**With 16:1 Handpiece (30 to 3,125 RPM)**  
#MOTOR-DUAL-16-1..... **6470.00**

*Irrigation Tubing On Page 53*



Bone Saws Fit Your Existing Implant Motor

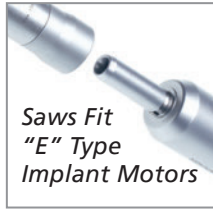

Saws Fit "E" Type Implant Motors

- Easily Cut Channels & Bone Blocks
- Very Useful For Ridge Osteoplasty
- Universal "E" Type Coupling Fits All Implant Motors
- Includes External Irrigation & Tubing
- Maximum 15,000 Oscillations Per Minute



Sagittal Bone Saw

Easily Harvests Blocks From The Ramus Or Mandible

#SAG-SAW . . . . . 1615.00 EACH  
(Blades Sold Separately)

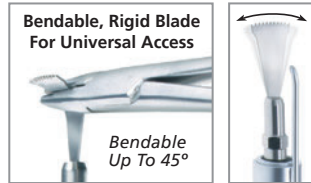

**MOST POPULAR**



4mm Blade-  
Medium Shank

#SAG-BLAD-4-M

93.50 PKG OF 6



6mm Round Blade-  
Medium Shank

#SAG-BLAD-6R-M

93.50 PKG OF 6



6mm Blade-  
Medium Shank

#SAG-BLAD-6-M

93.50 PKG OF 6



6mm Blade-  
Long Shank

#SAG-BLAD-6-L

93.50 PKG OF 6



10mm Blade-  
Long Shank

#SAG-BLAD-10-L

93.50 PKG OF 6

(Saw Blades Shown Actual Size)

Oscillating Bone Saw

#OSCIL-SAW . . . . 1615.00 EACH  
(Blades Sold Separately)



**MOST POPULAR**



6mm Blade

#OSCIL-BLAD-6

61.90 EACH

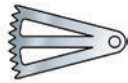

10mm Blade

#OSCIL-BLAD-10

61.90 EACH



5mm Blade

#OSCIL-BLAD-5

61.90 EACH

(Saw Blades Shown Actual Size)

Reciprocating Bone Saw

**MOST POPULAR**

#RECIP-SAW . . . . 1615.00 EACH  
(Blades Sold Separately)

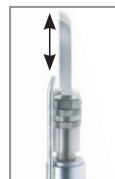

**MOST POPULAR**



11mm Cutting Length Blade

#RECIP-BLAD-10

93.50 PKG OF 6



14mm Cutting Length Blade

#RECIP-BLAD-15

93.50 PKG OF 6

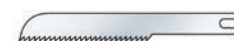

17mm Cutting Length Blade

#RECIP-BLAD-17

93.50 PKG OF 6



22mm Cutting Length Blade

#RECIP-BLAD-21

93.50 PKG OF 6

(Saw Blades Shown Actual Size)

**Disposable Irrigation Tubing Fits Nouvag & Salvin Implant Motor Systems**

- Includes Tubing From Solution Bag To Handpiece
- Works With Internal, External Irrigation, Or Both
- Packaged Sterile For One-Time Use

#NOU-IRR-TUBE-DISP ..... 191.60 PKG OF 10  
2 OR MORE ..... 177.10 PKG OF 10



**Nouvag & Salvin Motor Tubing Irrigation Needle**

#NOU-IRR-NEEDLE ..... 51.90 EACH



*Fits NOUVAG & SALVIN Single & Dual Motors*

**Disposable Irrigation Tubing Fits W&H Implant Motor Systems**

- Includes Tubing From Solution Bag To Handpiece
- Works With Internal, External Irrigation, Or Both
- Packaged Sterile For One-Time Use

#WH-IRR-TUBE-DISP ..... 191.60 PKG OF 10  
2 OR MORE ..... 177.10 PKG OF 10



*Fits W&H Motors Except Elcomed 100 Or 200 System*

*Motor & Handpiece Manufacturer's Names Are Trademarks Of Their Respective Companies.*

**Handpiece Maintenance**



**Lubricant Spray**

- Protect Your Handpiece Investment
- Minimize Interrupted Surgeries
- Use Daily And Before Every Sterilization Cycle For 1 Second
- Available In US Only

#NOU-OIL ..... 70.90 EACH



**Cleaning Spray**

- Protect Your Handpiece Investment
- Minimize Interrupted Surgeries
- Flushes & Cleans Debris From Handpiece
- Available In US Only

#NOU-CLEAN ..... 70.90 EACH

Salvin Universal Drill Stop Kit



**Universal Drill Stop Kit Fits  
The Implant Drills You Already Have!**

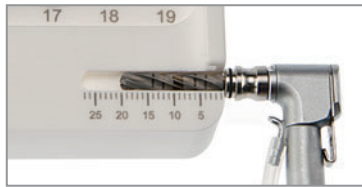

*With The Mount On The Drill,  
Measure From The Tip Of The  
Drill To The Mount*



*Select & Mount  
The Appropriate Length  
Drill Stop*



*Measure With Drill Stop  
Attached To Confirm  
Desired Drill Depth*



*Includes Autoclavable Block,  
13 Stops & 2 Mounts*

**BUYER'S GUIDE**



**For Standard Drills Without Collars**  
#DRILL-STOP-KIT . . . . . 659.00 KIT  
(Fits Drills Less Than 4.0mm)



**For Drills With Wide Collars**  
#DRILL-STOP-WIDE-KIT . . . . . 659.00 KIT  
(Fits Drills Less Than 4.0mm)



**Salvin Tri-Spade Intermediate Implant Drills Save You Money**

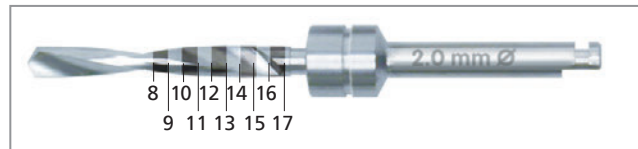

2.00mm Implant Drill

#IMPL-DRILL-2.00 . . . . . 99.60 EACH



2.75mm Implant Drill

#IMPL-DRILL-2.75 . . . . . 99.60 EACH



3.30mm Implant Drill

#IMPL-DRILL-3.30 . . . . . 99.60 EACH



3.50mm Implant Drill

#IMPL-DRILL-3.50 . . . . . 99.60 EACH

**SPECIAL** 4 Or More Intermediate Drills (YOUR ASSORTMENT) . . . . . **89.90 EACH**

**Salvin**  
**POWER POINT® Pilot Drills**

*Ultra Sharp For Precise Re-Angulation In Any Bone Density*

- Easy To Read Depth Markings
- Chatter-Free

**MOST POPULAR**

**Salvin POWER POINT®  
Ultra Sharp Implant Pilot Drills**

1.3mm Diameter - Overall Length 33mm

#PILOT-DRILL . . . . . 152.20 SET OF 2  
2 OR MORE . . . . . 142.30 SET OF 2

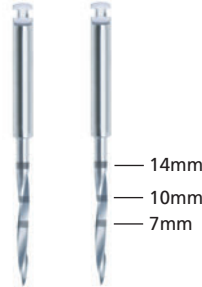

**MOST POPULAR**

**Salvin POWER POINT®  
Ultra Sharp Implant Pilot Drills-Long**

1.3mm Diameter - Overall Length 43mm

#PILOT-DRILL-LONG . . . . . 152.20 SET OF 2  
2 OR MORE . . . . . 142.30 SET OF 2

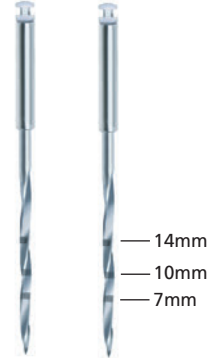

**Drill Extender & Pilot Drills**



**Implant Drill Extender -  
Extends 16mm**

- Fits Latch Type Implant Drills
- #DRILL-EXTENDER . . 74.70 EACH



2.0mm Inside  
(3.0mm Outside)

**2mm Trepine Pilot Drill**

- Harvest Bone As You Drill  
Primary Osteotomy
- #TREP-2 . . . . . 112.50 EACH



**MOST POPULAR**

**Lance Pilot Drill**

- 27mm Length
- #IMPL-DRILL-LANCE . . 58.90 EACH  
2 OR MORE . . . . . 54.40 EACH



**Implant Pilot Drill - Round**

- 22mm Length #6 Round
- #IMPL-DRILL-ROUND . . 17.90 EACH  
5 OR MORE . . . . . 15.60 EACH

**SPECIAL**

**"Hole In One" Pilot Drill Kit**

**MOST POPULAR**

**Includes:**

- 2 Salvin **POWER POINT®** Pilot Drills - 43mm
- 2 Salvin **POWER POINT®** Pilot Drills - 33mm
- 1 Lindemann Side Cutting Bur - 27mm
- 1 Round Implant Pilot Drill
- 1 Stainless Steel Bur Block

#HOLE-IN-ONE-KIT . . . . . **391.00 KIT W/BLOCK**



*This Kit Fits Latch-Type Handpieces*

**Meisinger Diamond Saw Discs**



**7mm Diameter Diamond Saw Disc**

- 0.3mm Disc Thickness
  - Fits Latch Type Handpieces
- #SAW-DISC-231DC . . . . . 78.75 EACH  
3 OR MORE . . . . . 75.90 EACH



**10mm Diameter Diamond Saw Disc**

- 0.3mm Disc Thickness
  - Fits Latch Type Handpieces
- #SAW-DISC-231DC/100 . . . . . 82.15 EACH  
3 OR MORE . . . . . 78.90 EACH



**13mm Diameter Diamond Saw Disc**

- 0.3mm Disc Thickness
  - Fits Latch Type Handpieces
- #SAW-DISC-231DC/130 . . . . . 95.60 EACH  
3 OR MORE . . . . . 89.90 EACH



**Saw Disc Kit For Latch Type Handpieces**

- 7mm Saw Disc
  - 10mm Saw Discs (2)
  - 13mm Saw Disc
- #SAW-DISC-KIT . . . . . 303.35 KIT

**MOST POPULAR**



Oral Surgery Burs



**Lindemann Side Cutting Bur-SU**

- Fits Friction Grip Handpieces
- 11mm Head Length

#LINDEMANN-SU

INDIVIDUALLY . . . . .81.20 EACH  
2 OR MORE . . . . .75.60 EACH



**Lindemann Side Cutting Bur Non-Irrigated - 27mm Long**

**MOST POPULAR**

#LINDEMANN

INDIVIDUALLY . . . . .81.20 EACH  
2 OR MORE . . . . .75.60 EACH



**Lindemann Side Cutting Bur Non-Irrigated - 32mm Long**

**MOST POPULAR**

#LINDEMANN-LONG

INDIVIDUALLY . . . . .81.20 EACH  
2 OR MORE . . . . .75.60 EACH



**Lindemann Side Cutting Bur-HP**

- Fits Straight Handpieces
- 44mm Long

#LINDEMANN-HP

INDIVIDUALLY . . . . .81.20 EACH  
2 OR MORE . . . . .75.60 EACH



**700 XXXL Implant Carbides**

- Fits Friction Grip Handpiece
- 30mm Long

#700 XXXL

SET OF 5 . . . . . 87.70 SET OF 5  
2 OR MORE SETS . . . 81.10 SET OF 5



**700 XXL Implant Carbides**

**MOST POPULAR**

- Fits Friction Grip Handpiece
- 25mm Long

#700 XXL

INDIVIDUALLY . . . . .16.40 EACH  
12 OR MORE . . . . .14.40 EACH



**Pikos Scoring Bur**

**MOST POPULAR**

- #8 Round Scoring Bur
- Depth Marked At 15mm
- Fits Straight Handpieces
- 44mm Long

#PIKOS-SCORINGBUR

INDIVIDUALLY . . . . .7.20 EACH  
10 OR MORE . . . . .5.70 EACH



**Pikos Osteotomy Bur**

**MOST POPULAR**

- 702-L Fits Straight Handpieces
- 44mm Long

#PIKOS-OSTEO-BUR-S

INDIVIDUALLY . . . . .7.20 EACH  
10 OR MORE . . . . .5.70 EACH

- 703 Fits Straight Handpieces
- 44mm Long

#PIKOS-OSTEO-BUR-L

INDIVIDUALLY . . . . .7.20 EACH  
10 OR MORE . . . . .5.70 EACH



**NEW!**

**Zygomatic Trough Bur**

- 2.3mm Pear Shape
- Fits Straight Handpieces
- 44mm Long

#MEIS-HM77MF-023-HP

INDIVIDUALLY . . . . . 28.45 EACH  
10 OR MORE . . . . . 26.95 EACH

**SPECIAL**

**Pikos Block Graft Kit**

**MOST POPULAR**

**Includes:**

- 2 Pikos 702-L Osteotomy Burs
- 2 Pikos #8 Round Scoring Burs
- 1 Pikos Large Round Block Contouring Bur
- 1 0.8mm Diameter Perforation Drill
- 1 Stainless Steel Bur Block

#PIKOS-BUR-KIT. . . . . 149.20 KIT W/BLOCK

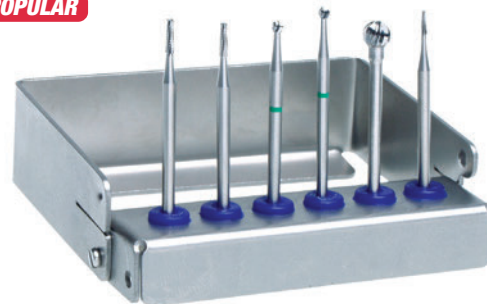

Special Purpose Drills & Burs



**Pikos Block Contouring Bur**

**MOST POPULAR**

- Fits Latch Type Handpieces
  - 25mm Long
- #PIKOS-BLOCK-CONTOUR-RA**  
INDIVIDUALLY . . . . . 48.90 EACH  
2 OR MORE . . . . . 44.10 EACH
- Fits Straight Handpieces
  - 44mm Long
- #PIKOS-BLOCK-CONTOUR**  
INDIVIDUALLY . . . . . 48.90 EACH  
2 OR MORE . . . . . 44.10 EACH



**0.8mm Bone Perforation Decorticating Drill**

- Fits Latch Type Handpieces
  - 27mm Long
- #PERF-DRILL-0.8-RA**  
INDIVIDUALLY . . . . . 86.30 EACH  
3 OR MORE . . . . . 77.40 EACH
- Fits Straight Handpieces
  - 43mm Long
- #PERF-DRILL-0.8-HP**  
INDIVIDUALLY . . . . . 86.30 EACH  
3 OR MORE . . . . . 77.40 EACH



**Sinus Scoring #8 Diamond**

**MOST POPULAR**

- Fits Latch Type Handpieces
  - 22mm Long
- #SINUS-SCORE-DIAM-RA**  
INDIVIDUALLY . . . . . 18.50 EACH  
10 OR MORE . . . . . 16.20 EACH
- Fits Straight Handpieces
  - 44mm Long
- #SINUS-SCORE-DIAM-HP**  
INDIVIDUALLY . . . . . 18.50 EACH  
10 OR MORE . . . . . 16.20 EACH



**Sectioning Bur**

- 703L Surgical Length Friction Grip Bur
  - 25mm Long
- #SECTION-BUR-703FG**  
INDIVIDUALLY . . . . . 7.20 EACH  
2 OR MORE . . . . . 6.20 EACH



**Ridge Contouring Bone Bur**

- Contour & Reshape Bone Anatomy
  - Fits Latch Type Handpiece
  - 25mm Long
- #RIDGE-CONTOUR**  
INDIVIDUALLY . . . . . 138.20 EACH  
2 OR MORE . . . . . 131.30 EACH



**1.2mm Step Drill Urban Decorticating Bur**

- Fits Latch Type Handpieces
  - 21mm Long
- #MEIS-2035-012-RA**  
PACK OF 2 . . . . . 102.90 PKG/2  
2 OR MORE PACKS . . . 93.70 PKG/2



**Neumeier Root Planing Bur-FG**

- Fits Friction Grip Handpieces
  - 20mm Long
- #NEUMEYER-FG**  
INDIVIDUALLY . . . . . 17.40 EACH  
10 OR MORE . . . . . 15.30 EACH



**Wire Passing Bur**

- Fits Straight Handpieces
  - 1.5mm Diameter
  - 5cm (2") Long
- #WIRE-PASS-1.5**  
INDIVIDUALLY . . . . . 102.50 EACH  
2 OR MORE . . . . . 95.90 EACH



**MetalKut™ Carbides**

- Our MetalKut™ Carbides Cut Through Metal Like Butter!
  - Fits Friction Grip Handpiece
  - 20mm Long
- #MKUT-PLUS**  
INDIVIDUALLY . . . . . 13.10 EACH  
12 OR MORE . . . . . 11.20 EACH

**SPECIAL**

**Rasmussen Biologic Shaping Bur Kit**

**Includes:**

- 2 1.6mm Coarse Flat End Taper Friction Grip Burs
- 2 1.6mm Fine Flat End Taper Friction Grip Burs
- 1 1.0mm Round End Needle Tip Diamond
- 1 2.3mm Round Friction Grip Diamond
- 1 2.3mm Fine Football Shaped Friction Grip Bur
- 1 Stainless Steel Bur Block

**#RASMUSSEN-BUR-KIT . . . . . 106.40 KIT W/BLOCK**



**SPECIAL**

**Peri-Implantitis Bur Kit**

- Tungsten Carbide Burs Clean & Smooth Titanium Surfaces
- 32mm Long FG Shanks To Reach Difficult To Access Implants
- Different Shapes & Sizes For Variety Of Individual Cases
- Fits Friction Grip Handpieces

**Includes:**

- 4 Egg Shaped Burs
- 4 Flame Shaped Burs

#PERIIMPLANTITIS-BURS . . . . . **141.60 KIT W/BLOCK**



**SPECIAL**

**P.E.T. Partial Extraction Therapy Bur Kit - FG**

**FG Shanks**

Fits Friction Grip Handpieces

**Includes:**

- Short 1.2mm Diameter Bone Cutter
- Long 1.2mm Diameter Bone Cutter
- Coarse 1.0mm Round Diamond Bur
- 1.8mm Round Prep Bur
- 2.3mm Round Prep Bur
- 2.9mm Round Prep Bur
- Stainless Steel Bur Block

#PET-BUR-KIT . . . . . **141.60 KIT W/BLOCK**



**SPECIAL**

**P.E.T. Partial Extraction Therapy Oral Surgery Bur Kit - HP**

**HP Shanks**

Fits Straight Handpieces

**Includes:**

- 701L Bur HP
- 1703 Bur HP
- 1.8mm Round Diamond HP
- 3.1mm Round Bur HP
- Lindemann Bur HP
- 2.3mm Pointed Football Diamond HP
- Stainless Steel Bur Block

#PET-OS-BUR-KIT . . . . . **141.60 KIT W/BLOCK**



**SPECIAL**

**Degranulation Bur Kit**

- Multiuse Burs (Typically 100 Procedures)
- Designed For Quick & Effective Bone Debridement
- Removes Remnants Of Tissue Attached To Bone
- Fits Latch Type Implant Handpieces

**Includes:**

- 1.0mm Degranulation Bur
- 2.5mm Degranulation Bur
- 3.0mm Degranulation Bur
- 3.5mm Degranulation Bur



#DEGRANULATION-KIT . . . . . **229.00 KIT W/BLOCK**

**SPECIAL**

**Alveoplasty Bur Kit**

- Smooth & Re-Contour Bone Following Tooth Extraction To Provide Ideal Platform For Denture Preparation Or Full Arch Restoration
- Prepare Bone For Implant Placement

**Includes:**

- 2 Lindemann Bone Cutters (Fits Friction Grip Handpieces)
- 2 Initial Starter Drills (Fits Friction Grip Handpieces)
- 1 Round Diamond (Fits Straight Handpieces)
- 5 Carbide Alveoplasty Burs With Round Ends To Protect Tissue (Fits Straight Handpieces)



#MEIS-ALV18 . . . . . **286.40 KIT W/BLOCK**

**SPECIAL**

**Crown Removal Bur Kit**

- For Cutting Crowns & Bridges
- Includes Burs For Every Type Of Restorative Material
- Recommended Cutting Angle Of 45°
- Optimum Speed Of 160,000rpm
- Fits Friction Grip Handpieces

#MEIS-BC04 . . . . . **139.90 KIT W/BLOCK**



**SALVIN®**  
**RotoBrush-Titanium®**  
For Exposed Implant Threads  
*On Page 63*









### Salvin Long Trepine Drills

*For Failed Implant Retrieval & Bone Harvesting*

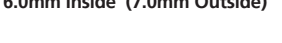

*Internally Irrigated*

-  2.0mm Inside Diameter x 22mm Barrel  
#TREP-H-2 ..... 112.50 EACH
-  3.5mm Inside Diameter x 22mm Barrel  
#TREP-H-3.5 ..... 112.50 EACH
-  4.25mm Inside Diameter x 22mm Barrel  
#TREP-H-4 ..... 112.50 EACH
-  5.0mm Inside Diameter x 22mm Barrel  
#TREP-H-5 ..... 112.50 EACH
-  6.0mm Inside Diameter x 22mm Barrel  
#TREP-H-6 ..... 112.50 EACH
-  8.0mm Inside Diameter x 22mm Barrel  
#TREP-H-8 ..... 112.50 EACH

**SPECIAL**

**Long Trepine Kit**



**MOST POPULAR**

**Internally Irrigated**

Set Of 6 Long Trephines With **FREE** Bur Block

- Fits Latch Type Handpieces
- Marked At 8, 10, 13 & 15mm

#TREP-H-KIT  
..... 569.00 KIT W/BLOCK

### Salvin Short Trepine Drills

*For Bone Harvesting*



-  2.0mm Inside Diameter x 10mm Barrel  
#TREP-H-SHORT-2 ..... 112.50 EACH
-  4.0mm Inside Diameter x 10mm Barrel  
#TREP-H-SHORT-4 ..... 112.50 EACH
-  6.0mm Inside Diameter x 10mm Barrel  
#TREP-H-SHORT-6 ..... 112.50 EACH
-  8.0mm Inside Diameter x 10mm Barrel  
#TREP-H-SHORT-8 ..... 112.50 EACH
-  10.0mm Inside Diameter x 10mm Barrel  
#TREP-H-SHORT-10 ..... 112.50 EACH
-  12.0mm Inside Diameter x 10mm Barrel  
#TREP-H-SHORT-12 ..... 112.50 EACH

**SPECIAL**

**Short Trepine Kit**



Set Of 6 Short Trephines With **FREE** Bur Block

- Fits Latch Type Handpieces
- Marked At 2, 4, 6, 8 & 10mm

#TREP-H-SHORT-KIT  
..... 569.00 KIT W/BLOCK

Autoclavable Bur Blocks & Baskets



**MOST POPULAR**

**6 Bur Block - Latch & Friction Grip**

#BUR-BLOCK-6-RA.....	57.00 EACH
3 OR MORE .....	53.10 EACH



**MOST POPULAR**

**6 Bur Block - Straight Handpiece**

BUR-BLOCK-6-HP.....	57.00 EACH
3 OR MORE .....	53.10 EACH



**8 Bur Block - Latch & Friction Grip**

#BUR-BLOCK-8-RA.....	57.00 EACH
3 OR MORE .....	53.10 EACH



**12 Bur Block - Latch & Friction Grip**

#BUR-BLOCK-12-RA.....	57.00 EACH
3 OR MORE .....	53.10 EACH



**Autoclavable Bur/Parts Basket**

46mm Diameter

#BUR-BASKET .....	69.90 EACH
3 OR MORE .....	66.50 EACH



**12 Compartment Autoclavable Parts Cassette**

21cm x 6cm x 2cm

#CASS-SS-PARTS-12.....	97.90 EACH
3 OR MORE .....	92.10 EACH

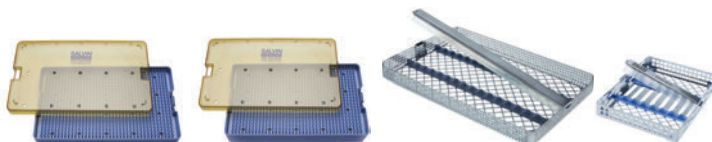

*Instrument Cassettes On Page 42-43*

**“Rear-Exhaust” 45° High Speed Surgical Drill**

*Creates Maximum Access & Visibility On 3rd Molars*

- No Air, Just Water In Surgical Field - Air Exits At Rear Of Handpiece For Safety
- High Speed: 380,000 - 450,000rpm
- High Torque: 21W Of Cutting Power



Push-Button Bur Release Uses Standard Friction Grip Burs



**45° High Speed Handpiece With Swivel 4 Hole Connector**

*New Version With Higher Torque*

#SURG-45-PKG. . . . . 1070.00 EACH

**Handpiece Without Connector**

*New Version With Higher Torque*

#SURG-45. . . . . 875.00 EACH



**Fiber Optic 45° High Speed Handpiece With Swivel 5 Hole Fiber Optic Connector**

*New Version With Higher Torque*

#SURG-45-FO-PKG. . . . . 1335.00 EACH

**Handpiece Without Connector**

*New Version With Higher Torque*

#SURG-45-FO. . . . . 1085.00 EACH



**Fiber Optic Fits Kavo® MULTiflex® Connector**

#SURG-45-FO-K . . . . . 1245.00 EACH

**Lubricant For 45° High Speed Handpiece**



**Pana Spray Lubricant - 10.5 oz.**

Available In US Only

#PANA-SPRAY . . . . . 69.70 EACH

# SALVIN® RotoBrush-Titanium® For Exposed Implant Threads

- Cleans Infected Implant Surface Without Grinding The Threads
- Maintains Structure & Shape Of The Implant
- Gentler On Implant Surface Than Diamond Burs & Ultrasonics
- Start At 300rpm Working Up To 1,200rpm As Needed



**MOST POPULAR**

### RotoBrush-Titanium® For Vertical Access

Single Use  
#ROTOBRUSH-POCKET ..... 37.60 EACH  
3 OR MORE ..... 33.70 EACH



### RotoBrush-Titanium® For Posterior Access

Single Use  
#ROTOBRUSH-SHORT-POCKET ..... 37.60 EACH  
3 OR MORE ..... 33.70 EACH



### RotoBrush-Titanium® For Wide Area

Single Use  
#ROTOBRUSH-OMEGA ..... 37.60 EACH  
3 OR MORE ..... 33.70 EACH



### RotoBrush-Titanium® Short For Wide Area

Single Use  
#ROTOBRUSH-DELTA-S ..... 37.60 EACH  
3 OR MORE ..... 33.70 EACH



**MOST POPULAR**

### RotoBrush-Titanium® For Non-Flap Case

Single Use  
#ROTOBRUSH-NANO ..... 37.60 EACH  
3 OR MORE ..... 33.70 EACH



**MOST POPULAR**

### RotoBrush-Titanium® For Flap Open Case

Single Use  
#ROTOBRUSH-2D-LONG ..... 37.60 EACH  
3 OR MORE ..... 33.70 EACH



*Fits Latch Type  
Implant Handpiece*



*Gently Cleans  
Implant Surface*

## SPECIAL

### Salvin RotoBrush-Titanium® Kit



**MOST POPULAR**

#### Includes:

- 2 RotoBrush-Titanium® Pocket
- 2 RotoBrush-Titanium® Nano
- 2 RotoBrush-Titanium® 2D-Long
- **FREE** Autoclavable Bur Block

#ROTOBRUSH-KIT  
**199.00 KIT WITH BUR BLOCK**

## Peri-Implantitis Tungsten Carbide Bur Kit

### SPECIAL

#### Peri-Implantitis Bur Kit

- Tungsten Carbide Burs Clean & Smooth Titanium Surfaces
- 32mm Long FG Shanks To Reach Difficult To Access Implants
- Different Shapes & Sizes For Variety Of Individual Cases
- Includes: 4 Egg Shaped Burs & 4 Flame Shaped Burs
- Fits Friction Grip Handpieces

#PERIIMPLANTITIS-BURS ..... **141.60 KIT W/BLOCK**





# Impla-Safe™

## Peri-Implant Management Set

Designed By Dr. George Kotsakis

*For Prevention And Non-Surgical Management  
Of Peri-Implantitis*

**NEW!**



Depth Marked  
At 1-15mm

### Impla-Safe™ Perio Probe

Titanium  
Flexible  
Ultra Thin

#IMPLA-SAFE-PROBE  
.....99.00 EACH



### Impla-Safe™ Mirror #4

Double Sided

#IMPLA-SAFE-MIRROR  
..... 99.00 BOX OF 6

### Impla-Safe™ Mirror Handle

#MIRROR-HNDL-BLK  
.....65.00 EACH



### Impla-Safe™ Soft Curette 3/4

Titanium  
For Supragingival Calculus

#IMPLA-SAFE-SOFT-TI-CURETTE  
.....99.00 EACH



### Impla-Safe™ Cement Explorer™

Titanium  
High Modulus Of Elasticity For  
Optimal Tactile Sensitivity

#IMPLA-SAFE-EXPLORER  
.....99.00 EACH



### Impla-Safe™ Cement Remover

Titanium  
Micro-Serrated For Efficient  
Cement Removal

#IMPLA-SAFE-CEM-REMOVER  
.....99.00 EACH



### Impla-Safe™ Titanium Micropliers - Curved

Titanium  
#IMPLA-SAFE-MICROPLIERS  
.....129.00 EACH

**PERI-IMPLANTITIS NON-SURGICAL TREATMENT  
– IMPLA-SAFE PROTOCOL**

**1 Probe The Sulcus & Assess For Calculus Using  
Impla-Safe Probe To Avoid Tissue Seal Rupture**



**If Calculus Present**



Remove Calculus Using Impla-Safe Soft Curette  
(Only On Abutments – Never On Implant Threads)

**2 Use Impla-Safe Cement Explorer For Detection  
Of Residual Cement**



**If Residual Cement Is Present**



Use Impla-Safe Cement Remover  
To Chip Off Cement

**3 Subgingival Irrigation With Saline**

**4 Shoe-Shine Implant Surface –  
Use Impla-Safe Ti Micropliers To Safely Push  
Gauze Soaked In Saline In The Sulcus**



"Impla-Safe is the first fully implant-specific instrument set for peri-implant maintenance, and for the prevention and non-surgical management of peri-implant inflammation. From the flexible probe to the soft titanium alloy instruments for implant-specific factors, such as excess cement, this set addresses the iatrogenic damage caused to implants by dental instruments and scaling using an evidence-based workflow. Should be integral in the maintenance of patients with dental implants."

**Dr. George Kotsakis**  
Periodontist, Hoboken, NJ



"These exceptionally well crafted implant site specific instruments for detecting and removing excess cement are a brilliant innovation and must have for all implant surgically based clinicians."

**Dr. Michael A. Pikos**  
Oral Surgeon, Palm Harbor, FL



"The Impla-Safe set is a game-changing, revolutionary implant-specific solution!"

**Dr. Jennifer Hirsch Doobrow**  
Periodontist, Cullman, AL



"I'm excited to see an implant specific solution with instruments that adapt to the shape of implant-supported restorations and can help detect excess cement during and after cementation."

**Dr. Konstantinos Choclidakis**  
Prosthodontist, Rochester, NY



"The Impla-Safe Protocol and instrument set addresses what has been missing in peri-implantitis treatment: an evidence-based, implant-specific solution for our patients."

**Dr. Eduardo R. Lorenzana**  
Prosthodontist, San Antonio, TX

**SPECIAL**

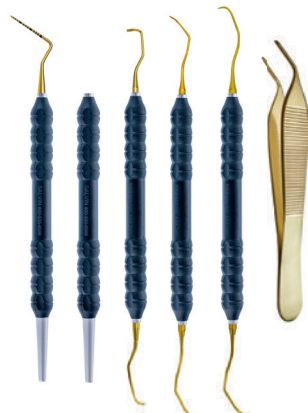

**Impla-Safe™  
Peri-Implant Management Set**

**INCLUDES:**

- Impla-Safe™ Probe
- Impla-Safe™ Mirror Handle
- Box of 6 Impla-Safe™ Mirrors
- Impla-Safe™ Titanium Curette
- Impla-Safe™ Cement Explorer™

- Impla-Safe™ Cement Remover
- Impla-Safe™ Titanium Micropliers
- Instrument Cassette

**#IMPLA-SAFE-INSTR-SET**

.....**694.00 SET**

**NEW!**

**SALVIN**  
**AutoTome®-Osteotome**  
 Automatic Osteotome Kit



- *Automatic Osteotome For Crestal Sinus Lifts & Maxillary Bone Spreading*
- *Ensures Precision And Saves Time*
- *Enhanced Patient Safety And Comfort*
- *One-Hand Operation For Visibility & Ease Of Use*
- *Creates An Osteotomy For Most Major Implant Systems*

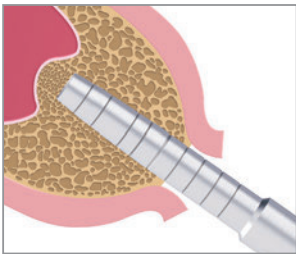

*Atraumatic, Controlled Bone Preparation*

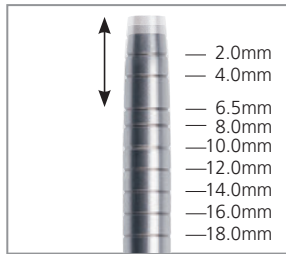

*Gentle Auto Tapping Easily Advances Osteotomy While Spreading Bone*



*Fits Your Existing Implant Motor*



*Set Your Motor To 12,000-15,000 RPM Translates To 120-150 Gentle Taps Per Minute (Max 15,000 RPM)*

**SPECIAL**

**AutoTome® Osteotome Starter Kit With Offset Tips**

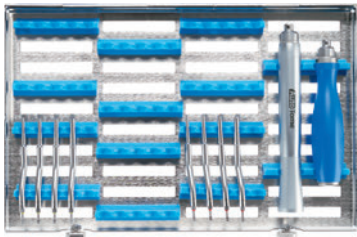

**Includes:**

- 1 AutoTome® Handpiece
- 1 Manual Handpiece For Use With Mallet When Desired
- 8 Osteotome Tips (4 Offset Concave, 4 Offset Convex) (2.0-2.8mm, 2.5-3.3mm, 3.0-3.9mm, 3.5-4.5mm Diameters)
- 1 Sterilization Cassette

#AUTOTOME-OST-STARTER-KIT ..... **2260.00 KIT**

**SPECIAL**

**AutoTome® Combination Osteotome & Extraction Kit**

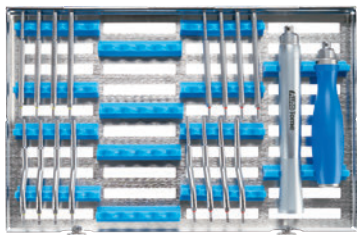

**Includes:**

- 1 AutoTome® Handpiece
- 1 Manual Handpiece
- 16 Osteotome Tips
- Sterilization Cassette
- 6 Periotome Tips
- 1 Autoclavable Tip Block

#AUTOTOME-COMP-KIT ..... **3590.00 KIT**



*Conventional Osteotomes On Pages 97-98 & 107*

**SALVIN**  
**AutoTome®-Extract**  
Automatic Extraction Kit

- Automatic Periotome For Root Elevation & Extraction
- Ensures Precision And Saves Time
- Enhanced Patient Safety And Comfort
- One-Hand Operation For Visibility & Ease Of Use
- Gentle Tapping Facilitates Atraumatic Controlled Extractions

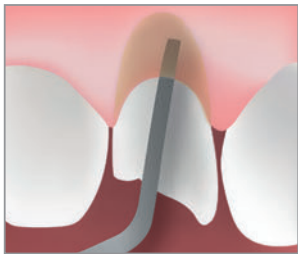

Bone Preserving  
Atraumatic Extraction

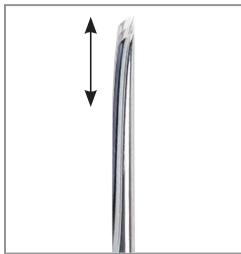

Gentle Auto Tapping  
Easily Facilitates  
Controlled Extractions



Fits Your  
Existing  
Implant Motor

**SPECIAL**



**AutoTome® Extraction Kit With Handpiece**

**Includes:**

- 1 AutoTome® Handpiece
- 6 Periotome Tips
- 1 Autoclavable Tip Block

#AUTOTOME-EXTRACT..... **1770.00 KIT**

**SPECIAL**



**AutoTome® Extraction Tip Kit**

(If You Already Have An AutoTome® Handpiece)

**Includes:**

- 6 Periotome Tips
- 1 Autoclavable Tip Block

#AUTOTOME-EXTRAC-TIPS..... **835.00 KIT**

**Replacement AutoTome® Extraction Tips**

Straight Narrow - 2.1mm	#AUTOTOME-EXT-TIP-1	141.00 EACH
Straight Wide - 2.6mm	#AUTOTOME-EXT-TIP-2	141.00 EACH
Angled Vertical - 2.1mm	#AUTOTOME-EXT-TIP-3	141.00 EACH
Angled Horizontal - 2.1mm	#AUTOTOME-EXT-TIP-4	141.00 EACH
Straight Narrow Concave - 2mm	#AUTOTOME-EXT-TIP-5	141.00 EACH
Straight Medium Concave - 3mm	#AUTOTOME-EXT-TIP-6	141.00 EACH

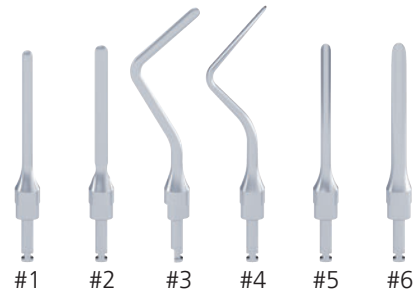

Conventional Periotomes On Pages 68-71



SALVIN  
**PDL-Evator®**  
Precise Tip Luxating Elevator

*Combines The Benefit Of A Periotome & Elevator In One Instrument*



**MOST POPULAR** **PDL-Evator® Straight - 2.5mm Tip**  
2.5mm Narrow Tip Is Thin Enough To Insert In Tight Spaces  
Between The Root And The Socket Wall  
#PDL-STRAIGHT..... 149.70 EACH



**MOST POPULAR** **PDL-Evator® Curved**  
#PDL-CURVED ..... 149.70 EACH



**MOST POPULAR** **PDL-Evator® Bayonet**  
#PDL-BAYONET ..... 149.70 EACH



**PDL-Evator® Angled "In" Small**  
#PDL-IN-SMALL ..... 149.70 EACH



**PDL-Evator® Angled "Out" Small**  
#PDL-OUT-SMALL ..... 149.70 EACH



**PDL-Evator® Angled "In" Large**  
#PDL-IN-LARGE ..... 149.70 EACH



**PDL-Evator® Angled "Out" Large**  
#PDL-OUT-LARGE..... 149.70 EACH

SPECIAL



**SALVIN**  
**PDL-Evator®**  
Precise Tip Luxating Elevator

**MOST POPULAR**

Includes:

- Set Of 7 Precise Tip Luxating Elevators
- **FREE** Stainless Steel Cassette

#PDL-PKG  
**1029.00 SET OF 7 W/CASSETTE**

“Interchangeable Tip” Periotomes



**MOST POPULAR**

**Periotome Handle With 5 Interchangeable Tips**

#PERIOTOME-5-TIPS . . . . .278.20 SET



*Use BUR-BLOCK-6-HP On Page 61 To Easily Store Periotome Tips*

**Thin Straight Replacement Tip**  
#PERIOTOME-TIP-1 . . . . . 125.00 PKG OF 3



**Wide Straight Replacement Tip**  
#PERIOTOME-TIP-2 . . . . . 125.00 PKG OF 3



**Thin Angled Replacement Tip**  
#PERIOTOME-TIP-3 . . . . . 125.00 PKG OF 3



**Flat Angled Replacement Tip**  
#PERIOTOME-TIP-4 . . . . . 125.00 PKG OF 3



**Flat Wide Angled Replacement Tip**  
#PERIOTOME-TIP-5 . . . . . 125.00 PKG OF 3



Third Molar Elevators



**Third Molar Elevator - Left**  
#ELEV-THIRD-MOLAR-L. . . . . 104.40 EACH

**Third Molar Elevator - Right**  
#ELEV-THIRD-MOLAR-R. . . . . 104.40 EACH

Periotomes



**MOST POPULAR**

**Straight Periotome With Fixed Straight Tip**

#PERIOTOME-STR  
 ..... 97.90 EACH  
 3 OR MORE  
 ..... 94.20 EACH



**Straight Periotome With Fixed Rounded Tip**

#PERIOTOME-STR-ROUND  
 ..... 97.90 EACH  
 3 OR MORE  
 ..... 94.20 EACH

Serrated Tip

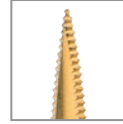

**Straight Periotome With Serrated Tip**

#PERIOTOME-SERR-STR  
 ..... 119.10 EACH  
 3 OR MORE  
 ..... 113.80 EACH



**Lane Elevator**

Designed By Dr. Bill Lane

#LANE-ELEVATOR  
 ..... 99.70 EACH  
 3 OR MORE  
 ..... 91.90 EACH

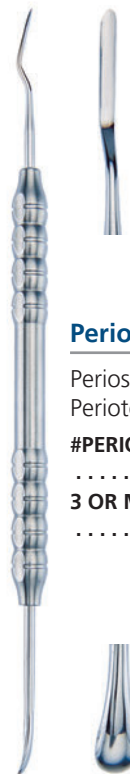

**Periosteal-Tome™**

Periosteal Elevator/  
 Periotome Combo

#PERIOSTEAL-TOME  
 ..... 104.40 EACH  
 3 OR MORE  
 ..... 98.90 EACH

Double-Ended Periostomes



**MOST POPULAR**

**Double Ended Periostome #1**

#PERIOTOME-DE-1  
..... 101.40 EACH  
3 OR MORE  
..... 93.90 EACH



**Double Ended Periostome #2**

#PERIOTOME-DE-2  
..... 101.40 EACH  
3 OR MORE  
..... 93.90 EACH



Serrated Tips

**Serrated Tip Periostome #1**

#PERIOTOME-SERR-1  
..... 119.10 EACH  
3 OR MORE  
..... 113.80 EACH

Serrated Tips



Serrated Tips

**Serrated Tip Periostome #2**

#PERIOTOME-SERR-2  
..... 119.10 EACH  
3 OR MORE  
..... 113.80 EACH

Serrated Tips



SALVIN<sup>®</sup>  
**AtrauLux<sup>®</sup>**  
Ergonomic Elevators



Handle Fits Comfortably In Palm  
For Increased Control



**MOST POPULAR**

AtrauLux<sup>®</sup> Elevator  
2mm Straight

#ATRAU-ELEV-2-STR  
.....91.20 EACH

SALVIN  
**Ergonomic  
Handle**



**MOST POPULAR**

AtrauLux<sup>®</sup> Elevator  
3mm Straight

#ATRAU-ELEV-3-STR  
.....91.20 EACH

SALVIN  
**Ergonomic  
Handle**



AtrauLux<sup>®</sup> Elevator  
4mm Straight

#ATRAU-ELEV-4-STR  
.....91.20 EACH

SALVIN  
**Ergonomic  
Handle**



AtrauLux<sup>®</sup> Elevator  
2mm Curved

#ATRAU-ELEV-2-CUR  
.....91.20 EACH

SALVIN  
**Ergonomic  
Handle**



AtrauLux<sup>®</sup> Elevator  
3mm Curved

#ATRAU-ELEV-3-CUR  
.....91.20 EACH

SALVIN  
**Ergonomic  
Handle**



AtrauLux<sup>®</sup> Elevator  
4mm Curved

#ATRAU-ELEV-4-CUR  
.....91.20 EACH

SALVIN  
**Ergonomic  
Handle**

**SPECIAL**

Set Of 6  
Salvin AtrauLux<sup>®</sup>  
Elevators

---

**MOST POPULAR**

#ATRAU-ELEV-SET-6  
494.00 SET OF 6

Serrated Elevators



Serrated Elevator 2.2mm

#DEL-SERR-2  
.....99.10 EACH

**MOST POPULAR**

Serrated Elevator 3mm

#DEL-SERR-3  
.....99.10 EACH

Serrated Elevator 4mm

#DEL-SERR-4  
.....99.10 EACH

Serrated Elevator 4mm - Left

#DEL-SERR-4-L  
.....99.10 EACH

Serrated Elevator 4mm - Right

#DEL-SERR-4-R  
.....99.10 EACH

**SPECIAL** **MOST POPULAR** Set Of 5 Serrated Elevators #DEL-SERR-SETOF5 .....**426.00 SET OF 5**

Atraumatic Bayonet Elevators

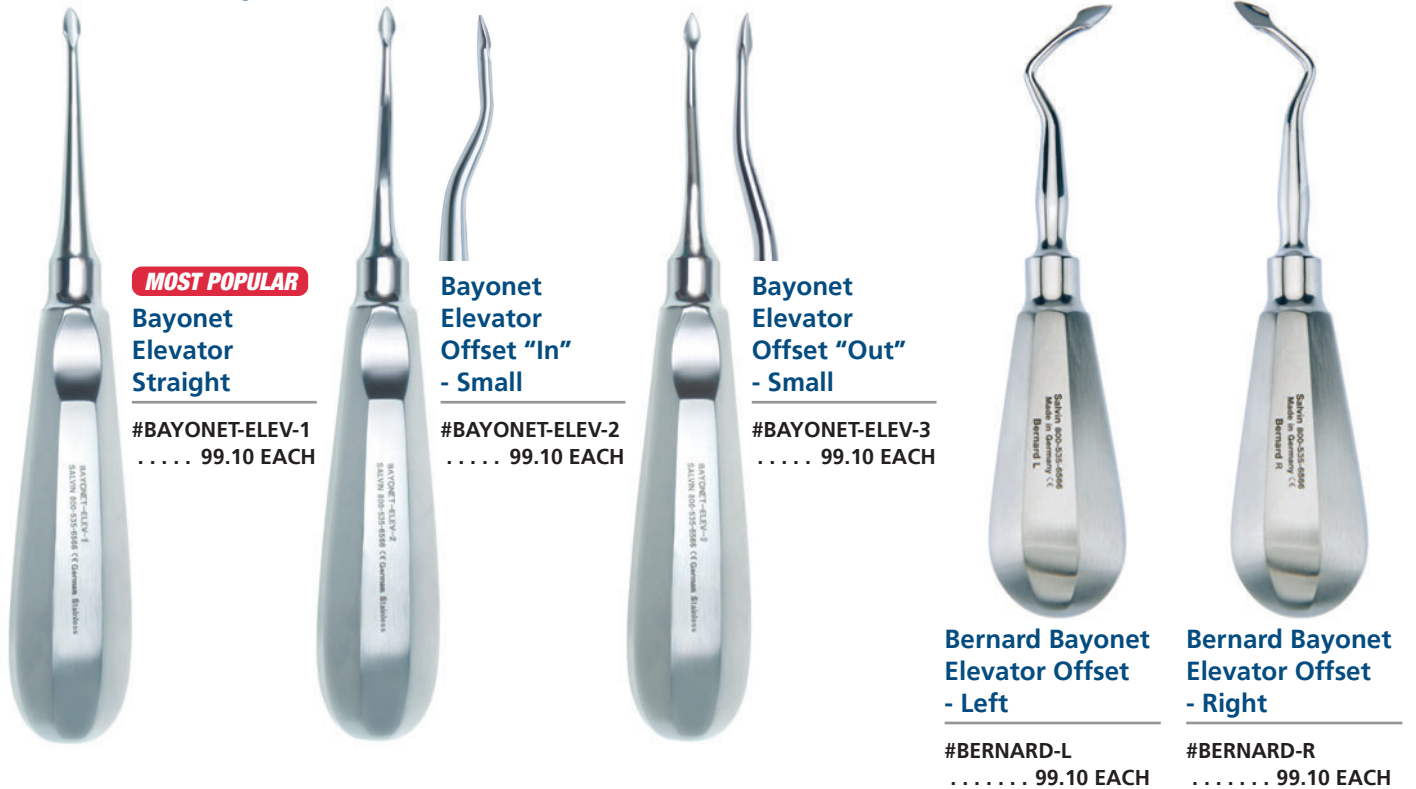

**MOST POPULAR**

Bayonet Elevator Straight

#BAYONET-ELEV-1  
..... 99.10 EACH

Bayonet Elevator Offset "In" - Small

#BAYONET-ELEV-2  
..... 99.10 EACH

Bayonet Elevator Offset "Out" - Small

#BAYONET-ELEV-3  
..... 99.10 EACH

Bernard Bayonet Elevator Offset - Left

#BERNARD-L  
..... 99.10 EACH

Bernard Bayonet Elevator Offset - Right

#BERNARD-R  
..... 99.10 EACH

**SPECIAL** **MOST POPULAR** Set Of 5 Bayonet Elevators #BAYONET-SETOF5 .....**426.00 SET OF 5**

Bone Preserving Atraumatic Luxating Elevators



3mm Luxating Elevator Curved

#LUX-3-CURVED  
..... 92.70 EACH



**MOST POPULAR**

3mm Luxating Elevator Straight

#LUX-3-STRAIGHT  
..... 92.70 EACH



5mm Luxating Elevator Curved

#LUX-5-CURVED  
..... 92.70 EACH



5mm Luxating Elevator Straight

#LUX-5-STRAIGHT  
..... 92.70 EACH

**SPECIAL**

Set Of 4 Luxating Elevators

**MOST POPULAR**

#LUX-SETOF4  
333.00 SET OF 4

"Anatomically Grooved" Luxating Elevators



**MOST POPULAR**

2mm Grooved Luxating Elevator

#LUX-GROOVE-2  
..... 92.70 EACH



3mm Grooved Luxating Elevator

#LUX-GROOVE-3  
..... 92.70 EACH



4mm Grooved Luxating Elevator

#LUX-GROOVE-4  
..... 92.70 EACH



5mm Grooved Luxating Elevator

#LUX-GROOVE-5  
..... 92.70 EACH

**SPECIAL**

Set Of 4 Grooved Elevators

#LUX-GROOVE-SETOF4  
333.00 SET OF 4

Luxating Elevators With Periotome Tip



**MOST POPULAR**

**3mm Luxating Elevator/Periotome**

#LUX-TOME-3  
..... 92.70 EACH



**4mm Luxating Elevator/Periotome**

#LUX-TOME-4  
..... 92.70 EACH



**5mm Luxating Elevator/Periotome**

#LUX-TOME-5  
..... 92.70 EACH

**SPECIAL**

**Set Of 3 Luxating Elevators**



#LUX-TOME-SETOF3  
**247.00 SET OF 3**

Thin Handle Luxating Elevators



**MOST POPULAR**

**2.5mm Thin Handle Luxating Elevator**

#LUX-THIN-2.5  
..... 92.70 EACH



**3.5mm Thin Handle Luxating Elevator**

#LUX-THIN-3.5  
..... 92.70 EACH

**SPECIAL**

**Set Of 2 Luxating Elevators**



#LUX-THIN-SETOF2  
**159.00 SET OF 2**



Salvin Twist Elevators

- Twist Design Provides Improved Vertical Movement Of The Tooth Over Conventional Elevators
- Sharp Tips Engage Tooth & Provide Deeper Subgingival Access



Twist Elevator  
Straight Left

#TWIST-ELEV-STR-L  
..... 105.90 EACH



Twist Elevator  
Straight Right

#TWIST-ELEV-STR-R  
..... 105.90 EACH



Twist Elevator  
Angled Left

#TWIST-ELEV-ANG-L  
..... 105.90 EACH



Twist Elevator  
Angled Right

#TWIST-ELEV-ANG-R  
..... 105.90 EACH

**SPECIAL**

Set Of 4 Salvin  
Twist Elevators

#TWIST-ELEV-SET-4  
375.00 SET OF 4

Elevators



Potts Elevator-  
Left

#POTTS-L  
..... 89.20 EACH



Potts Elevator-  
Right

#POTTS-R  
..... 89.20 EACH



Potts "T-Handle"  
Elevator-Left

#POTTS-T-L  
..... 95.20 EACH

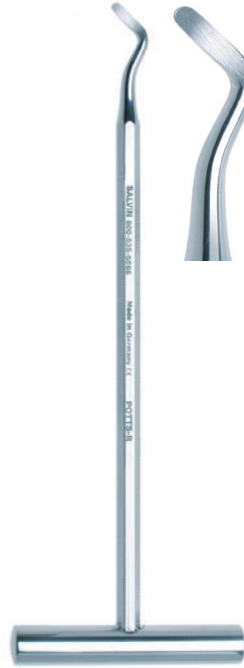

Potts "T-Handle"  
Elevator-Right

#POTTS-T-R  
..... 95.20 EACH



Coupland Gougé Elevator

Useful For Removal Of Teeth  
With Amputated Crowns

#COUPLAND-1C... 91.90 EACH

Elevators



Your Choice Of Elevators

INDIVIDUALLY . . . 90.40 EACH  
3 OR MORE . . . . 85.50 EACH

SALVIN<sup>®</sup>  
**AtrauLux<sup>®</sup>**  
Extraction Forceps

- Tapered Tips Adapt Exactly To The Tooth With Excellent Subgingival Contact
- Lightweight, Ergonomic Design Fits Both Right & Left Handed Practitioners

**SPECIAL** **MOST POPULAR**

**Set Of 9 Salvin AtrauLux<sup>®</sup> Forceps**

#ATRAU-FORCEP-SET-9 . . . 2090.00 SET OF 9

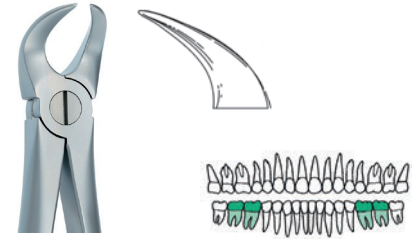

**AtrauLux<sup>®</sup> Forcep Cow Horn**

Serrated Beak  
Lower Atraumatic Extraction  
#ATRAU-FORCEP-COWHORN . . 273.90 EACH

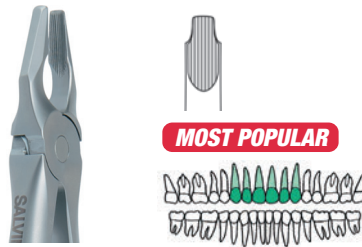

**AtrauLux<sup>®</sup> Forcep #1**

Serrated Beak  
Upper Anterior Atraumatic Extraction  
#ATRAU-FORCEP-1 . . . . . 273.90 EACH

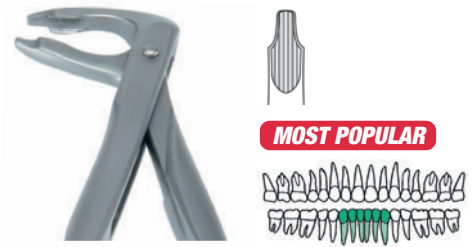

**AtrauLux<sup>®</sup> Forcep #2**

Serrated Beak  
Lower Anterior Atraumatic Extraction  
#ATRAU-FORCEP-2 . . . . . 273.90 EACH

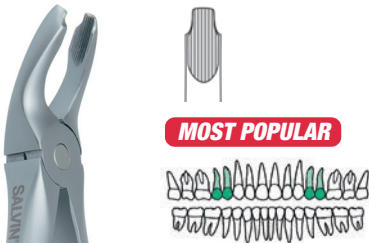

**AtrauLux<sup>®</sup> Forcep #3**

Serrated Beak  
Upper Premolar Atraumatic Extraction  
#ATRAU-FORCEP-3 . . . . . 273.90 EACH

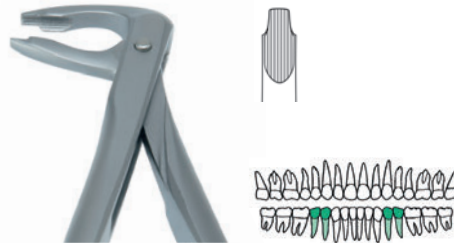

**AtrauLux<sup>®</sup> Forcep #4**

Serrated Beak  
Lower Premolar Atraumatic Extraction  
#ATRAU-FORCEP-4 . . . . . 273.90 EACH

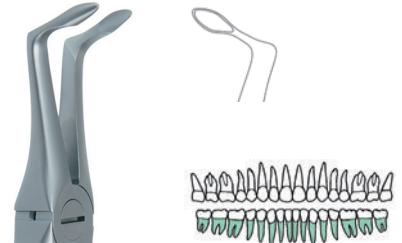

**AtrauLux<sup>®</sup> Forcep #5**

Lower Root Atraumatic Extraction  
#ATRAU-FORCEP-5 . . . . . 273.90 EACH

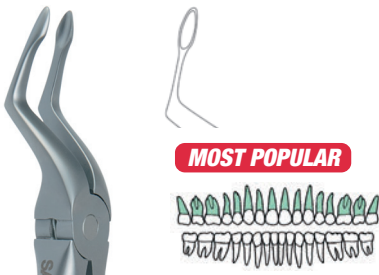

**AtrauLux<sup>®</sup> Forcep #6**

Upper Root Atraumatic Extraction  
#ATRAU-FORCEP-6 . . . . . 273.90 EACH

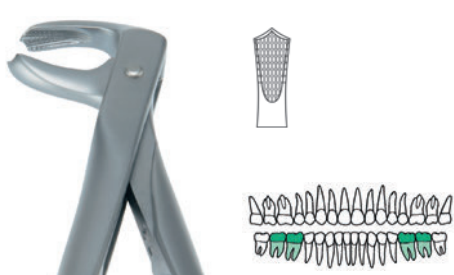

**AtrauLux<sup>®</sup> Forcep #7**

Serrated Beak  
Lower Molar Atraumatic Extraction  
#ATRAU-FORCEP-7 . . . . . 273.90 EACH

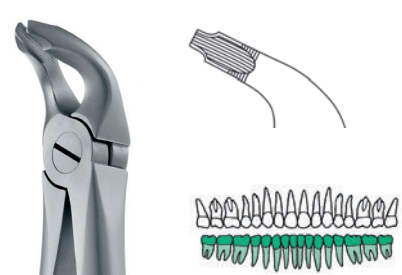

**AtrauLux<sup>®</sup> Forcep #8**

Serrated Beak  
Lower Atraumatic Extraction  
#ATRAU-FORCEP-8 . . . . . 273.90 EACH

**DEEP GRIP** Extended Tip Length Serrated Forceps

**BUYER'S GUIDE**

- ▶ Superior Grip & Tactile Feel Even With Limited Contact
- ▶ Less Time & Force Required, Even For Difficult Extractions

**SPECIAL** **MOST POPULAR**

**Set Of 4 DEEP GRIP Forceps**

#DGA-SET-4 ..... 889.00 SET OF 4



Tips Marked At  
1mm - 8mm Depths

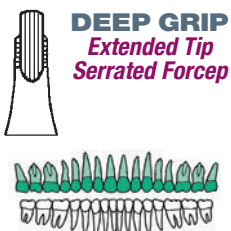

**DGA-34**

Serrated Beak  
Upper Atraumatic Extraction

#DGA-34..... 273.90 EACH

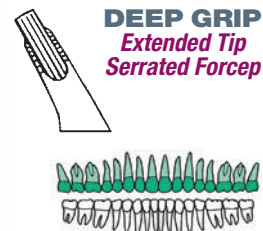

**MOST POPULAR**

**DGA-35**

Serrated Beak  
Upper Atraumatic Extraction

#DGA-35..... 273.90 EACH

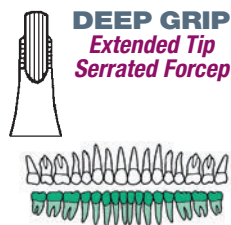

**DGA-36**

Serrated Beak  
Lower Atraumatic Extraction

#DGA-36..... 273.90 EACH

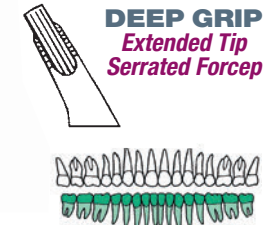

**MOST POPULAR**

**DGA-37**

Serrated Beak  
Lower Atraumatic Extraction

#DGA-37..... 273.90 EACH



Tungsten Carbide Tipped Root Tip Forceps

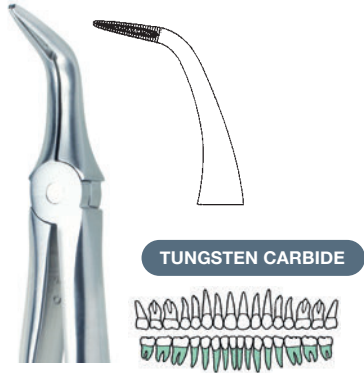

**MOST POPULAR**

**Root Tip-Lower**

Carbide Serrated Beak  
Lower Root Tips & Molars

#ROOT CU . . . . . 281.80 EACH

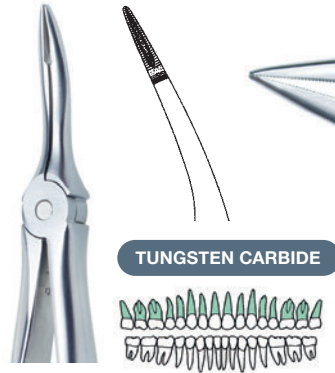

**MOST POPULAR**

**Root Tip-Upper**

Carbide Serrated Beak  
Upper Root Tips & Molars

#ROOT TC . . . . . 281.80 EACH



**DEF 859 TC**

Carbide Serrated Beak  
Lower Root Tips & Molars

#DEF859TC . . . . . 281.80 EACH

German Stainless Steel Extraction Forceps

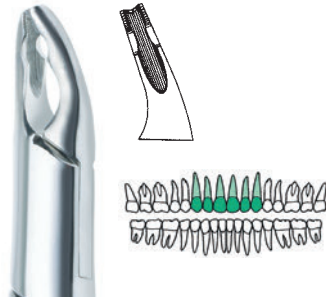

**DEF 150AS**

Serrated Beak  
Upper Anteriors, Split Beaks

#DEF150AS . . . . . 204.60 EACH

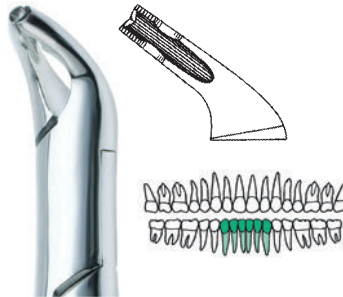

**DEF 151AS**

Serrated Beak  
Lower Anteriors, Split Beaks

#DEF151AS . . . . . 204.60 EACH

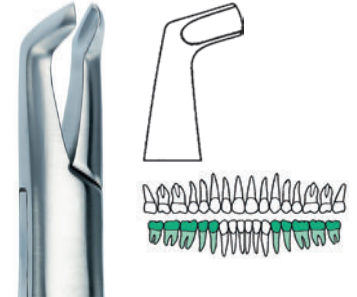

**DEF 222**

Lower Molars  
Excellent Access To 3rd Molars

#DEF-222 . . . . . 204.60 EACH

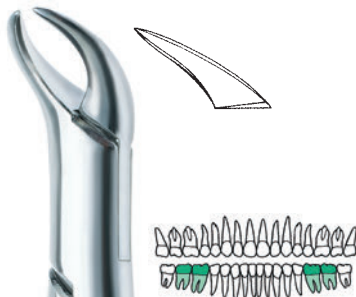

**MOST POPULAR**

**DEF 23-Lower**

Lower Cow Horn  
1st & 2nd Lower Molars

#DEF 23 . . . . . 204.60 EACH

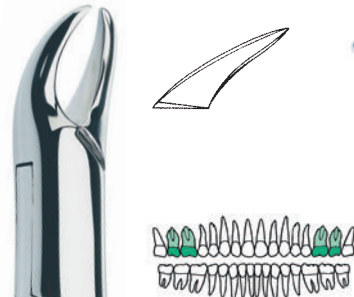

**DEF 23-Upper**

Upper Cow Horn  
1st & 2nd Upper Molars

#DEF-23-UPPER . . . . . 204.60 EACH

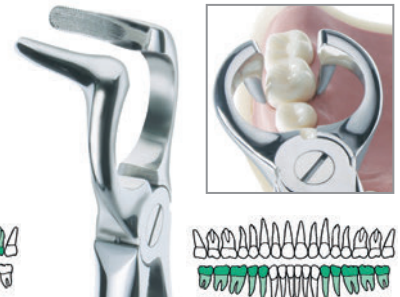

**Wrap Around Extraction Forcep**

Right Angle "Wrap Around" Design  
Provides Superior Access

Serrated Beak  
#DEF-68-WRAP . . . . . 204.60 EACH

Tungsten Carbide Tip Extraction Forceps – Better Grip & Tactile Feel – Less Trauma

**BUYER'S GUIDE**

- ▶ Superior Grip & Tactile Feel Even With Limited Contact
- ▶ Less Time & Force Required, Even For Difficult Extractions

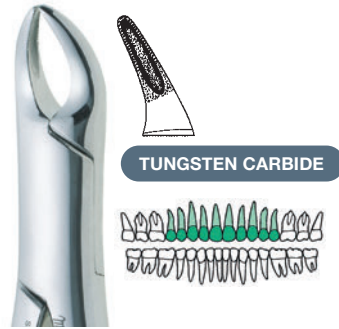

**MOST POPULAR**

**DEF 150 TC**

Carbide Serrated Beak  
Upper Incisors, Cuspids,  
Bicuspid & Roots, Universal  
#DEF 150 TC . . . . . 282.10 EACH



**MOST POPULAR**

**DEF 151 TC**

Carbide Serrated Beak  
Lower Incisors, Cuspids,  
Bicuspid & Roots, Universal  
#DEF 151 TC . . . . . 282.10 EACH

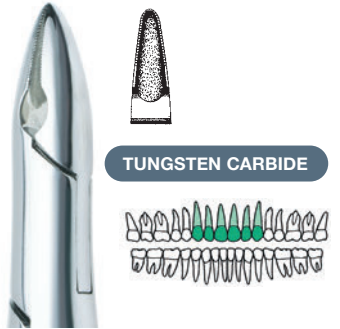

**DEF 1STD TC**

Carbide Serrated Beak  
Upper Incisors, Cuspids  
#DEF 1STD TC . . . 282.10 EACH



**DEF 17 TC**

Carbide Serrated Beak  
1st & 2nd Lower Molars,  
Universal  
#DEF 17 TC . . . . . 282.10 EACH

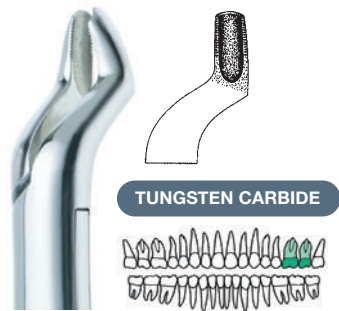

**DEF 53L TC**

Carbide Serrated Beak  
1st & 2nd Upper Molars, Left  
#DEF 53L TC . . . . . 282.10 EACH

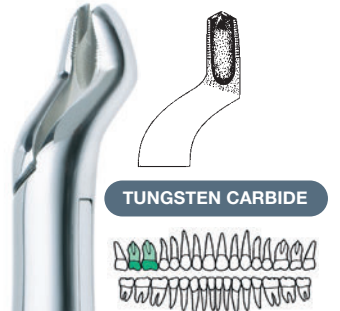

**DEF 53R TC**

Carbide Serrated Beak  
1st & 2nd Upper Molars, Right  
#DEF 53R TC . . . . . 282.10 EACH

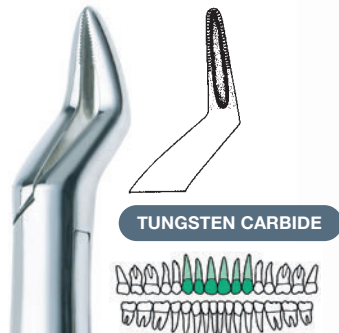

**DEF 65 TC**

Carbide Serrated Beak  
Upper Incisors,  
Roots & Fragments  
#DEF 65 TC . . . . . 282.10 EACH



**MOST POPULAR**

**DEF 69 TC**

Carbide Serrated Beak  
Upper & Lower  
Fragments & Roots  
#DEF 69 TC . . . . . 282.10 EACH



**DEF 150S TC Pedro Forcep**

Carbide Serrated Beak  
Pedro, Upper Primary  
Teeth & Roots, Universal  
#DEF 150S TC . . . 282.10 EACH



**DEF 151S TC Pedro Forcep**

Carbide Serrated Beak  
Pedro, Lower Primary  
Teeth & Roots, Universal  
#DEF 151S TC . . . 282.10 EACH

Bayonet Atraumatic Extraction Forceps



**MOST POPULAR**

**Bernard Forcep 153**

Upper Atraumatic Extraction

#BERNARD-153 ..... 214.40 EACH



**MOST POPULAR**

**Bernard Forcep 146**

Lower Atraumatic Extraction

#BERNARD-146 ..... 214.40 EACH



**Bernard Forcep 151**

Lower Atraumatic Extraction

#BERNARD-151 ..... 214.40 EACH

"Fish-Hook" Atraumatic Extraction Root Forceps



"Fish Hook"  
Serrations  
For Better  
Traction

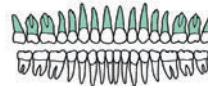

**45° Angled Root Forcep  
"Fish-Hook" Serrations**

Upper Atraumatic Extraction

#FHA-45 ..... 269.90 EACH

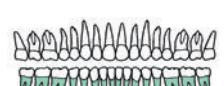

**90° Angled Root Forcep  
"Fish-Hook" Serrations**

Lower Atraumatic Extraction

#FHA-90 ..... 269.90 EACH

**SPECIAL**

#FISH-HOOK-SET-2 ..... 489.00 SET OF 2

**Physics Forceps® Standard Series**

- Predictable & Efficient Bone Preservation Extractions In Less Than Four Minutes
- Elimination Of Root Tip Fractures
- No Need For Elevating Or Laying A Flap
- Very Little Operator Movement Or Force Necessary



Photo: Dr. Randy Resnik



**Upper Left Forcep**

#PHYSICS-FORC-UP-L  
..... 625.00 EACH



**Upper Anterior Forcep**

#PHYSICS-FORC-UP-ANT  
..... 625.00 EACH



**Upper Right Forcep**

#PHYSICS-FORC-UP-R  
..... 625.00 EACH



**Lower Universal Forcep**

#PHYSICS-FORC-LOWER-U  
..... 625.00 EACH



**Bumper Guards**

#PHYSICS-GUARDS-24  
..... 25.80 EACH

**SPECIAL**

**Set Of 4 Physics Forceps®**

**Includes:**

- Upper Left Forcep
- Upper Anterior Forcep
- Upper Right Forcep
- Lower Universal Forcep
- 24 Bumper Guards

#PHYSICS-FORCEPS-SET4 ..... **1990.00 SET**



**Partial Extraction Therapy**

**SPECIAL**

**P.E.T. Partial Extraction Therapy Bur Kit**

Fits Friction Grip Handpieces

**Includes:**

- Short 1.2mm Diameter Bone Cutter
- Long 1.2mm Diameter Bone Cutter
- Coarse 1.0mm Round Diamond Bur
- 1.8mm Round Prep Bur
- 2.3mm Round Prep Bur
- 2.9mm Round Prep Bur
- Stainless Steel Bur Block

#PET-BUR-KIT ..... **141.60 KIT W/BLOCK**





Forceps & Root Tip Picks



Tungsten Carbide Tip  
20mm Tip Length  
For Deep Access

TUNGSTEN CARBIDE



**MOST POPULAR**

**TC Coated Tip  
Root Fragment Forcep**

Extended Tips For Excellent  
Access & Gripping

#FRAGMENT-FORCEP-TC . . . . . 234.70 EACH  
2 OR MORE . . . . . 222.10 EACH



**Warwick Root Tip  
Elevator - Left**

#WARWICK-L  
. . . . . 77.40 EACH



**Warwick Root Tip  
Elevator - Right**

#WARWICK-R  
. . . . . 77.40 EACH

**SPECIAL**

Set Of  
**Warwick Root Tip  
Elevators**

#WARWICK-SET  
**129.60 SET OF 2**



**Heidbrink H1**

Single-Ended  
#HEID 1  
. . . . . 71.10 EACH



**MOST POPULAR**

**Heidbrink H2**

Single-Ended  
#HEID 2  
. . . . . 71.10 EACH



**MOST POPULAR**

**Heidbrink H3**

Single-Ended  
#HEID 3  
. . . . . 71.10 EACH



**Heidbrink H2-H3**

Double-Ended  
#HEID 2/3  
. . . . . 71.10 EACH



Meisinger Benex Pro Atraumatic Extraction Kit

- Screw Action Lifting Makes Thin Buccal Plate Extractions Easy!
- Excellent For Use In The Aesthetic Zone

"I use the Benex Extractor on a daily basis in my office for difficult extractions to save time and preserve bone for implant placement."  
**-Dr. John Russo**  
 Periodontist, Sarasota, FL

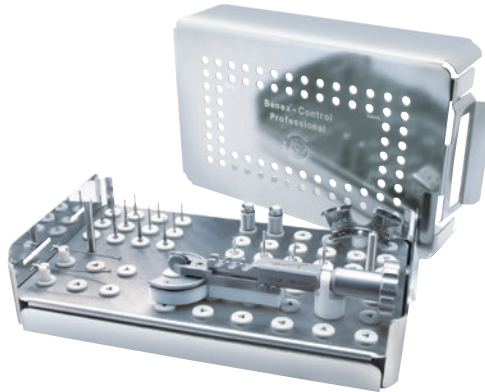

Drill Hole In Root

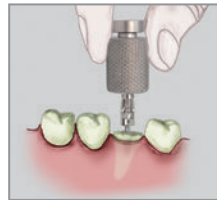

Insert Extraction Screw

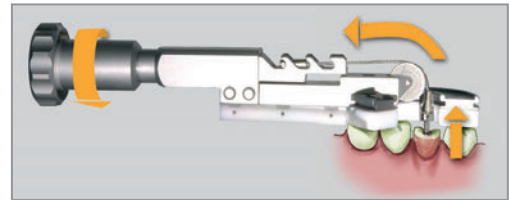

Turn Knob To Gently & Safely Extract Root

**SPECIAL**

Salvin Benex Atraumatic Kit

**MOST POPULAR**

Includes:

- Benex Extraction Handle
- Drills, Extraction Screws, Pull Wires
- Organizer Holds Both Parts & Handle
- Support Tray To Stabilize Handle If Required

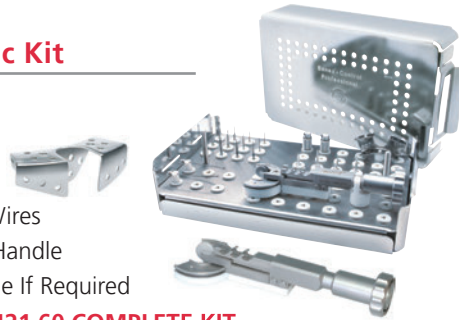

#BENEX-PRO .....**2421.60 COMPLETE KIT**

Replacement Parts For Benex Pro Atraumatic Extraction Kit



**Narrow Extraction Screw**

- 1.3mm x 10mm  
#MEIS-BE001-060  
..... 118.15 EACH
- 1.3mm x 16mm  
#MEIS-BE001-230-070  
..... 118.15 EACH



**Wide Extraction Screw**

- 2.1mm x 10mm  
#MEIS-BE001-230-080  
..... 118.15 EACH
- 2.1mm x 16mm  
#MEIS-BE001-230-085  
..... 118.15 EACH



**Traction String**

- #MEIS-BE001-230020  
..... 141.95 EACH



Salvin  
**POWER POINT**  
Pilot Drills  
On Page 55

Serrated Lucas Bone Currettes

*Serrated Tips Help Debride Extraction Sockets & Create Bleeding Points For Faster Healing*

Designed By Dr. Jin Kim

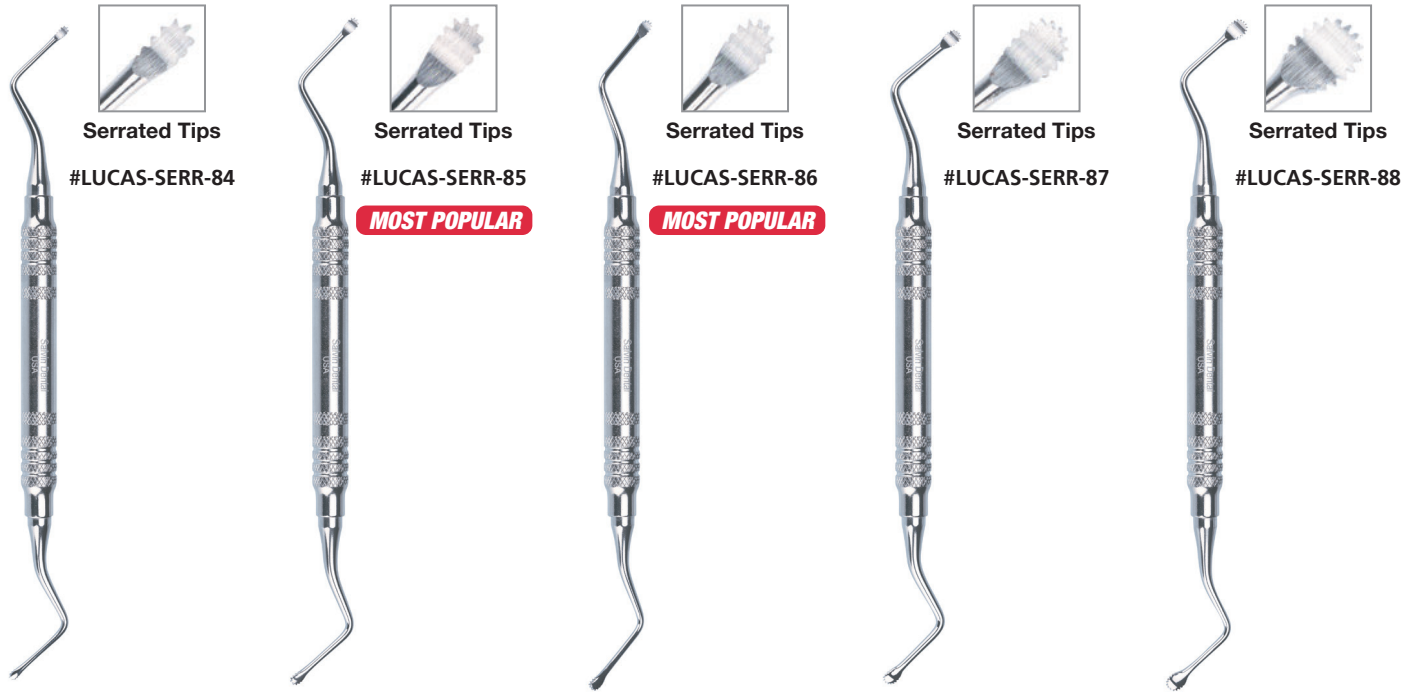

Serrated Lucas Bone Currettes

INDIVIDUALLY .....	75.90 EACH
3 OR MORE .....	70.50 EACH

Non-Serrated Lucas Currettes

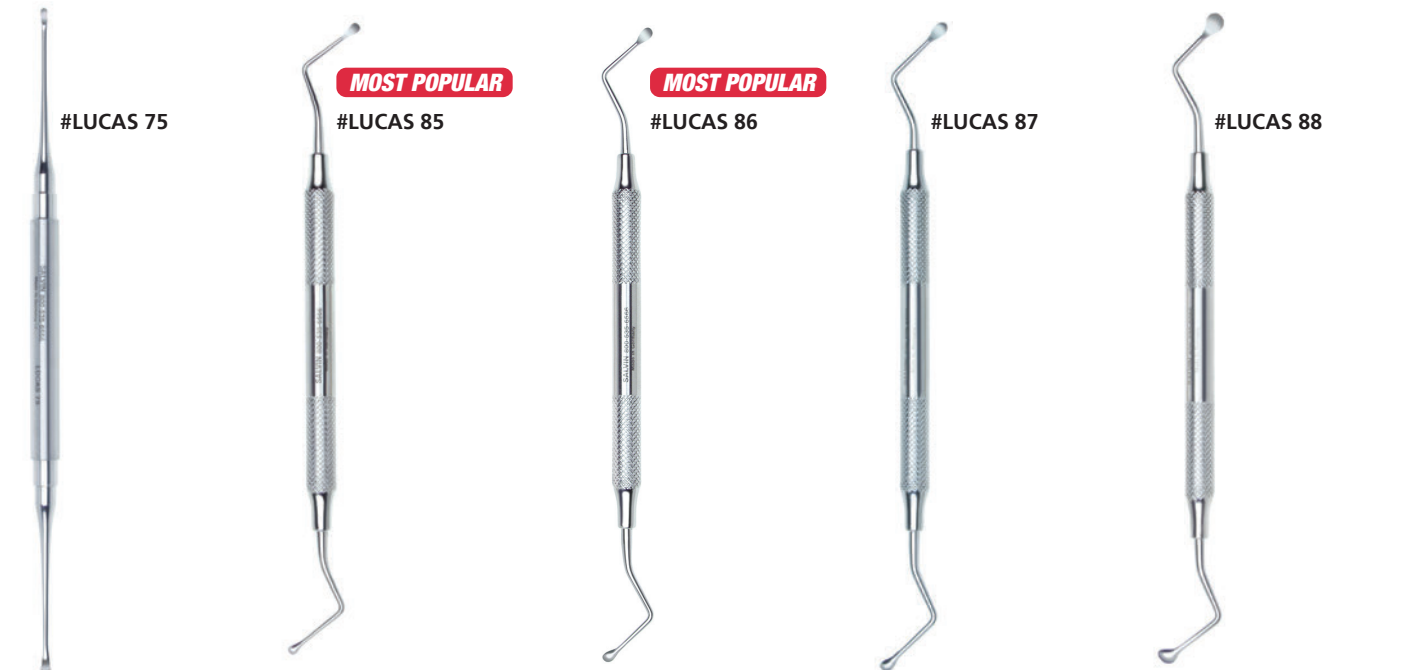

Non-Serrated Lucas Bone Currettes

INDIVIDUALLY .....	73.90 EACH
3 OR MORE .....	69.20 EACH

**Urban Master Core Kit**

*Simple And Safe Extraction Of Bone Cylinders For Bone Augmentation*

Developed By Dr. Istvan Urban

- Depth Limited Trepines
- Depth Markings For Additional Depth Cont
- Black Coating To Prevent Glare

**Master Core Kit**

- 6 7mm Trepines Of 3mm-8mm Lengths
- 5 5mm Trepines Of 4mm-8mm Lengths
- 3 3mm Trepines Of 6mm-8mm Lengths
- 1 3mm Trepine Of 2mm Length
- 1 5mm Trepine Of 2mm Length
- 1 7mm Trepine Of 2mm Length
- 1 Drill Extender

#MEIS-BMC00 ..... 1208.05 KIT



**Master Core Kit - Basic**

- 5 7mm Trepines Of 3mm-7mm Lengths
- 5 5mm Trepines Of 3mm-7mm Lengths
- 1 5mm Trepine Of 2mm Length
- 1 7mm Trepine Of 2mm Length
- 1 Drill Extender

#MEIS-BMCBA ..... 1075.65 KIT



**Autogenous Bone Grafting Bur Kits**



**Bone Chip Maker Bur Kit With Stops**

4 Bone Harvesting Trepines (3.4mm, 3.9mm, 4.2mm, 5.2mm), 4 Trepine Stops (5mm, 7mm, 10mm, 11.5mm), 1 Bone Remover & 1 Latch To Square Adapter

#BONE-CHIP-MAKER .....324.00 KIT



**Bone Collector Bur Kit**

5 Bone Collecting Drills (2.8mm, 3.3mm, 3.8mm, 4.3mm, 4.8mm), 5 Drill Stops (6mm, 8mm, 10mm, 11.5mm, 13mm)

#BONE-COLLECTOR-KIT .....324.00 KIT



## Graft Material Packers - Titanium

**MOST POPULAR**

### Titanium Graft Packer / Placement Site Depth Gauge

- Titanium For Biocompatibility
- Excellent In Difficult Access Sites
- 3.3mm & 4.0mm Diameter Tips
- Marked At 8, 11, 13, 15 & 18mm

#GRAFT-PACKER-TI . . . . . 123.60 EACH



**MOST POPULAR**

### Serrated Titanium Tip Graft Packer-Small

- Excellent In Difficult Access Sites
- 3mm & 4mm Diameter Tips

#GRAFT-PACK-SERR-S . . . . . 123.60 EACH



### Serrated Titanium Tip Graft Packer-Large

- Excellent In Difficult Access Sites
- 6mm & 8mm Diameter Tips

#GRAFT-PACK-SERR-L . . . . . 123.60 EACH

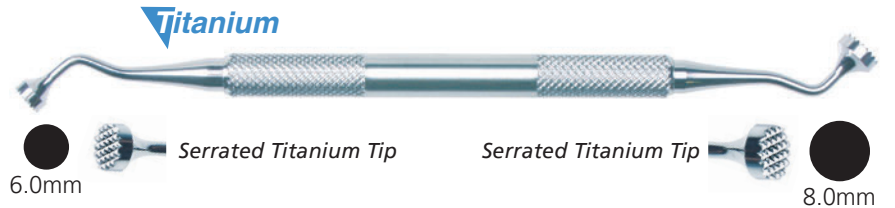

## Graft Material Packers - Stainless Steel

### Graft Packer

- Excellent In Difficult Access Sites
- 6mm & 8mm Diameter Smooth Tips

#GRAFT-PACKER . . . . . 104.30 EACH



### Pikos Graft Packer-Angled

- Concave Tips
- Excellent For Use In Sinus
- 4mm & 6mm Diameter Tips

#PIKOS-PACKER-ANGLED . . . . . 118.60 EACH

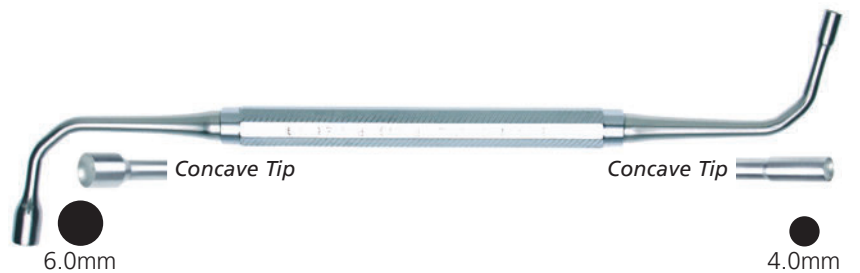

Curved Graft Packers For Pockets Around Implants - Titanium

**MOST POPULAR**

Curved Titanium Pocket Packer  
1.75mm Radius

3mm x 1mm Tip

#POCKET-PACKER-1.75

..... 99.20 EACH



Curved Titanium Pocket Packer  
2.5mm Radius

4mm x 1mm Tip

#POCKET-PACKER-2.5

..... 99.20 EACH



Graft Material Transfer Instruments

Graft Material Spoon With  
4mm Serrated Graft Packer

Concave Spoon Tip For Larger Grafts

#BONE-SPOON-PACK-4 . . . . . 117.90 EACH



**MOST POPULAR**

Graft Material Spoon With  
3mm Serrated Graft Packer

Concave Spoon Tip For Larger Grafts

#BONE-SPOON-PACKER . . . . . 117.90 EACH



Sinus Floor Elevator With  
3mm Graft Packer

- Marked At 7, 10, 12, 14, 16 & 19mm
- Designed By Dr. Richard Martin

#MARTIN-PLUGGER. . . . . 117.90 EACH



### Stainless Steel Graft Material Syringes

**MOST POPULAR**

#### 5mm Diameter Stainless Steel Syringe-Curved

#GRAFTSYRINGE-CURVED . . . . . 106.20 EACH

#### 3.6mm Diameter Stainless Steel Syringe-Curved

#GRAFT-SYR-S-CURV . . . . . 106.20 EACH

#### 2.8mm Diameter Stainless Steel Syringe-Curved

#GRAFT-SYR-2.8-CU . . . . . 106.20 EACH

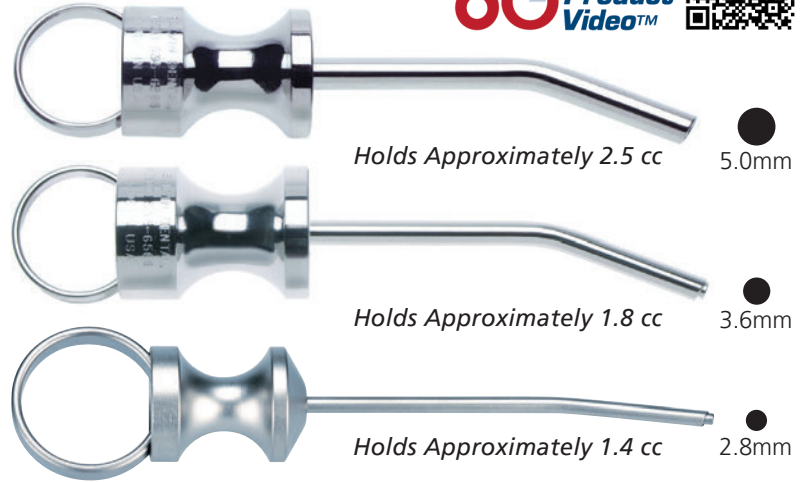

Load From Tip To Prevent Clogging

### Autoclavable Plastic Syringes For Smaller Grafts & Perio Defects

#### Perio Defect Graft Syringes

- Disassembles For Easy Cleaning
- Autoclavable, Chemiclavable

#HA SYRINGE . . . . . 64.10 SET OF 2  
2 OR MORE SETS . . . . . 58.50 SET OF 2

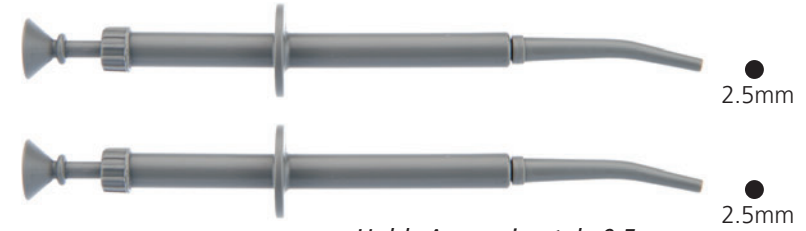

Holds Approximately 0.5 cc  
Sold As A Set Of 2 Syringes



Load From Tip To Prevent Clogging

### Single Use Plastic Bone Graft Delivery Syringes

#### Bone Graft Delivery Syringes

- Packaged Sterile
- Single Use
- Blunt 5mm Wide Tip For Ease Of Delivery

#BONE-SYRINGE-1CC . . . . . 48.90 PACK OF 10  
2 OR MORE PACKS . . . . . 46.50 PACK OF 10



Holds 1.0 cc  
Sold As A Pack Of 10 Syringes



Load From Tip To Prevent Clogging



Blunt 5mm Wide Tip For Ease Of Delivery

**Stainless Steel Graft Material Syringes**



**3.5mm Diameter Ring Handle Syringe-Curved**  
#GRAFT-SYRINGE-3.5. . . . . 199.20 EACH



**MOST POPULAR**  
**4.5mm Diameter Ring Handle Syringe-Curved**  
#GRAFT-SYRINGE-4.5. . . . . 199.20 EACH

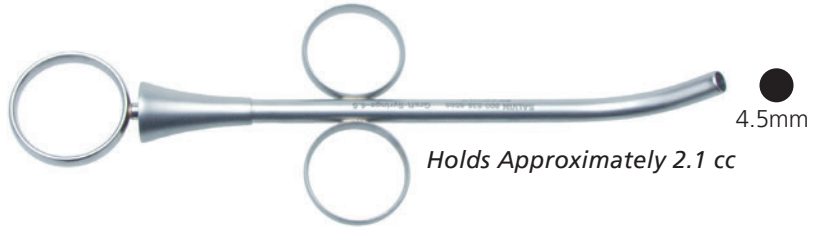

**6.0mm Diameter Ring Handle Syringe-Curved**  
#GRAFT-SYRINGE-6.0. . . . . 199.20 EACH

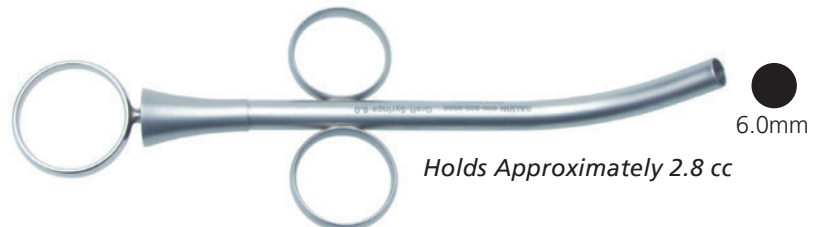

**Graft Material Mixing Dishes**



**MOST POPULAR**  
**Graft Material Mixing Cups**

- Deep Dish With Rounded Bottom
- Holds 4 To 6 Grams Of Hydrated Material
- Autoclavable, Chemiclavable
- Will Not Crack During Sterilization

#GRAFT MIX. . . . . 52.90 SET OF 2  
2 OR MORE SETS . . . . . 48.80 SET OF 2



**Stainless Steel Weighted Graft Material Dish**

- Deep Dish With Weighted Bottom To Prevent Tipping
- Holds 20 Grams Of Hydrated Material
- Autoclavable, Chemiclavable

#GRAFT-DISH . . . . . 56.30 EACH  
2 OR MORE . . . . . 52.40 EACH



# OsseoScape™ Angled Single Use Bone Harvester

Scan For  
**60<sup>th</sup> Second Product Video™**



**MOST POPULAR**



- Angled Lightweight Ergonomic Handle
- Collection Chamber Holds Approximately 1cc
- Autoclave Before Use

#OSSEO-SCRAPE ..... 177.00 BOX OF 5  
(Hex Driver Tip & Thumb Knob Sold Separately)



*For A New Sharp Edge,  
Use A 1.25mm Hex Driver Tip  
To Turn The Blade 90°*



**.05" (1.25mm) Hex Long - 12mm**

#HTLT ..... 57.40 EACH



**Thumb Knob**

#TK ..... 76.90 EACH

# Sterile Single Use Bone Harvester



- Angled Lightweight Ergonomic Handle
- Collection Chamber Holds Approximately 1cc
- Packaged Sterile

#BONE-SCRAPER-STERILE ..... 49.00 EACH  
(Hex Driver Tip & Thumb Knob Sold Separately)



*Angled Tip For Easy Access*



*Collection Chamber Holds  
Approximately 1cc*



*For A New Sharp Edge,  
Use A 1.25mm Hex Driver Tip  
To Turn The Blade 90°*

### Salvin Stainless Steel Bone Scraper

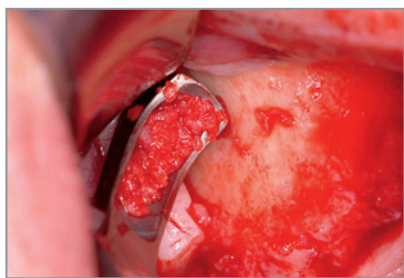

#### Stainless Steel Bone Scraper

- Clean & Autoclave For Repeated Use
- No Blade To Change

#BONE-SCRAPER ..... 178.30 EACH

### Osseous Collection Trap

- Stop Suctioning Usable Bone!
- Simplify Bone Harvesting With Our Osseous Trap



**MOST POPULAR**

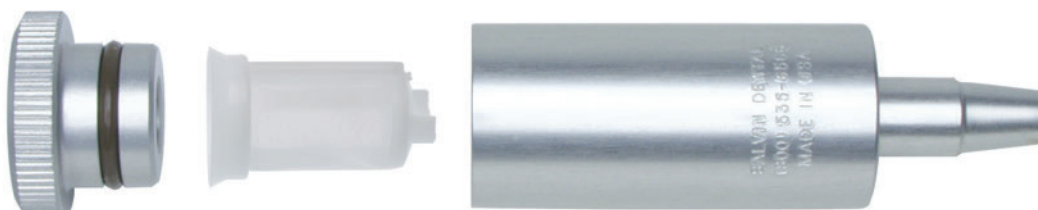

#### Osseous Coagulum Trap With 3 Single Use Filters

- Use "In Line" With Your Suction
- Osseous Material Is Collected Directly Into A Filter
- Can Be Chemiclaved, Autoclaved, Or Dry Heat Sterilized

#OCT ..... 129.00 EACH

- Uses Any Aspirator That Fits Into A High Volume Suction
- Fits Regular High Volume Suction As Well As Silicone Or Latex Surgical Suction Tubing



#### 3mm Stainless Steel Aspirator Tip

#15P3A ..... 39.00 EACH



#### Set Of 3 Replacement Single Use Filters

- Supplied Non-Sterile - Autoclave Before Using

#OCT FILTERS ..... .26.00 PKG OF 3  
3 OR MORE SETS ..... .24.50 PKG OF 3

Tissue Rakes & Flap Holding Forceps

For Greater Flap Release & Bone Graft Site Access



Separate Fibers For Increased Flap Release



Separate Fibers For Increased Flap Release



Retract Flap For Easy Access

Tissue Rake #1

Designed By Dr. Hom-Lay Wang  
For Increased Flap Extension

#TISSUE-RAKE-1 .....96.40 EACH

Tissue Rake #2

Designed By Dr. Hom-Lay Wang  
For Increased Flap Extension

#TISSUE-RAKE-2 .....96.40 EACH

Flap Holding Forcep

For Easy Bone Graft Site Access

#FLAP-FORCEP .....102.10 EACH

Bone Block Clamps

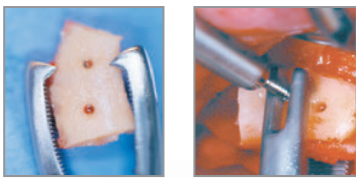

Screw Fits Through Notched Tip  
Photos: Dr. Yvan Poitras

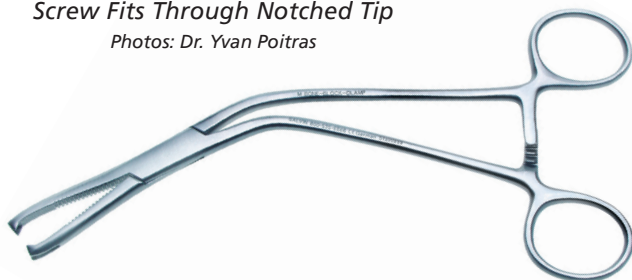

Anterior Cortical Block Clamp

- Ratchet Lock Holds Block In Place
- 19.7cm Long

#BONE-BLOCK-CLAMP .....359.50 EACH



Tightens To Hold Block In Place



Adjustable Straight Cortical Block Clamp

- Adjustable Width To Hold Block In Place
- 10cm Long

#BONE-CLAMP-ADJ .....294.90 EACH

## Hand-Held Bone Morselizer

**MOST POPULAR**

### Bone Morselizer

- Collected Bone Chips Ready To Use For Augmentation
- No Loss Of Bone Material
- Easy To Clean
- Adjustable Screw Allows You To Achieve Preferred Particle Size

#BONE-MORSELIZER . . . . . 604.00 EACH



16mm Diameter  
Titanium Morselizing Surface



## Bone Mill For Fast & Easy Crushing Of Cortical Bone

### Stainless Steel Bone Mill

- Easy Assembly & Cleaning
- No Loss Of Bone Material
- Bone Collected In Easy To Use Dish
- Collected Bone Chips Ready To Use For Bone Augmentation

#BONE-MILL-PLUS . . . . . 1915.00 EACH



Blade Morselizes  
Bone To Approximately  
3mm Particle Size



## Titanium Bone Cruncher™

### Bone Cruncher™

1. Place Harvested Bone In Well Of Instrument
2. Cover Bone With Top, Serrated Side Down
3. Use Mallet To Reduce To Desired Particle Size

#BONE-CRUNCHER . . . . . 330.00 EACH

### Mead Mallet

#MEAD . . . . . 167.00 EACH





**Comprehensive Lateral & Crestal Sinus Kit**

*Minimizes Risk Of Membrane Perforation*



*Diamond Tip  
Minimizes Risk  
Of Perforation*



*Trephinated Bur  
Cuts & Detaches  
Bony Wall*



*Dome Shape  
Minimizes Risk  
Of Perforation*



*Irrigation Lifts  
Membrane*



*Syringe Holder Helps Control  
Irrigation Flow*

**Complete Crestal & Lateral Sinus Kit**

#SINUS-COMP-KIT . . . . . 1595.00 EACH



6 Crestal Drills



8 Drill Stops



4 Crestal Burs



2 Lateral  
Trephinated Drills



2 Lateral Dome  
Shaped Burs



Irrigation Syringe  
With Tubing



8 Irrigation Tips



Syringe Holder



1 Sinus Depth Gauge/Packer

**Replacement Irrigation Syringe  
With Tubing**

#SINUS-MAS2-01-09 . . . . . 9.10 EACH

**Lateral Reamer 6.5mm x 2mm**

#SINUS-REAM-6.5X2 . . . . . 198.90 EACH

**Lateral Reamer 6.5mm x 3mm**

#SINUS-REAM-6.5X3 . . . . . 198.90 EACH

### Concave Tip Sinus Lift Osteotomes

A conventional osteotomy is made to the floor of the sinus. The Sinus Osteotome is inserted into the osteotomy & gently tapped apically to separate & lift the cortical bone at the sinus floor 2mm-4mm.



**MOST POPULAR**

#### Offset Sinus Lift Set

- 5 Offset Osteotomes With Adjustable Stops
- FREE Stainless Steel Cassette

#OST-SINUS-OFF-PKG . . . . . 751.00 SET

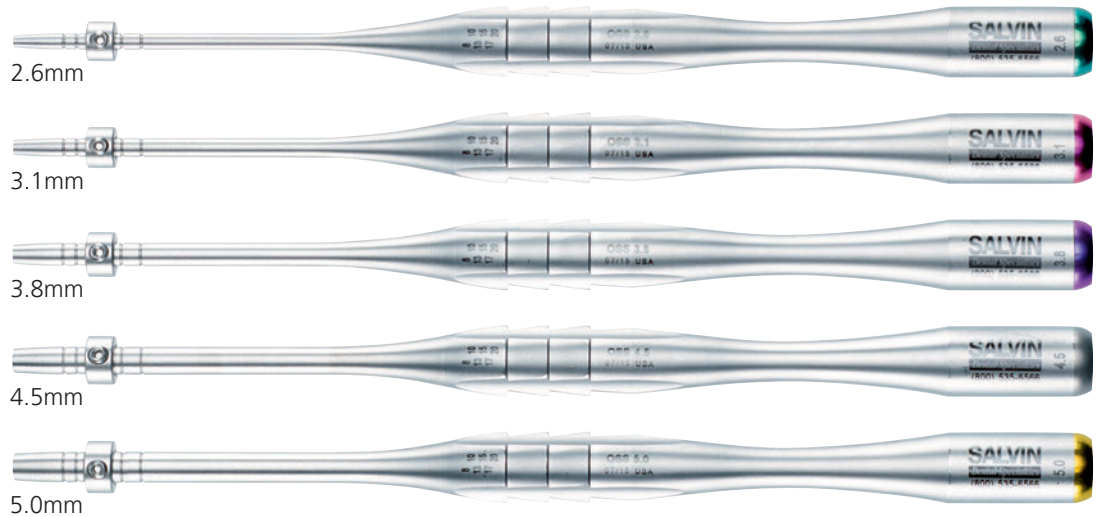

#### Straight + Offset Sinus Lift Set

- 5 Straight Osteotomes With Adjustable Stops
- 5 Offset Osteotomes With Adjustable Stops
- FREE Stainless Steel Cassette

#OST-SINUS-BOTH-PKG . . . . . 1349.00 SET



#### Straight Sinus Lift Set

- 5 Straight Osteotomes With Adjustable Stops
- FREE Stainless Steel Cassette

#OST-SINUS-STR-PKG . . . . . 751.00 SET

## Extended Length Osteotomes For Surgical Guides

Designed By Dr. Jack Krauser

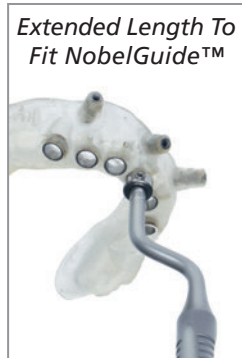
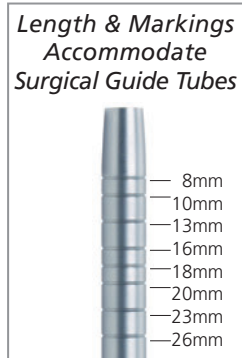

*NobelGuide™ is a Trademark of NobelBiocare*



### Extended Length Osteotome Set

- 5 Offset Osteotomes With Adjustable Stops
- FREE Stainless Steel Cassette

#GUIDE-TOME-PKG . . . . . 751.00 SET

- 2.0mm
- 4.0mm
- 6.5mm
- 8.0mm
- 10.0mm
- 12.0mm
- 14.0mm
- 16.0mm
- 18.0mm

**SALVIN**  
**AutoTome®**  
 Automatic Osteotome Kit  
*On Page 66*



### Meisinger Crestal Sinus Lift Kit

- *Depth Stops Prevent Puncturing Of The Sinus Membrane*
- *Concave Tipped Drills*
- *Crestal Drills Collect Bone Chips*
- *Can Be Used With Any Implant System*

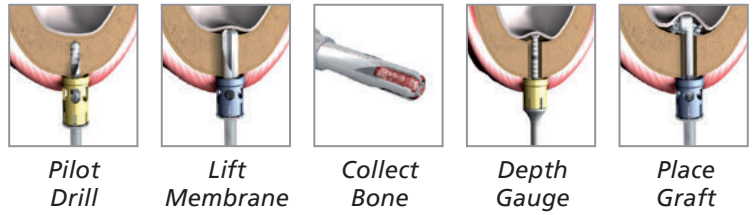

### Complete Crestal Sinus Lift Kit

6 Crestal Drills, 11 Drill Stops, 4 Pilot Drills, 1 Cylinder Bur, 2 Condensers & 1 Depth Gauge  
**#CRESTAL-LIFT-CONTROL . . . . . 1930.65 KIT**



### Basic Crestal Sinus Lift Kit 2 **MOST POPULAR**

4 Crestal Drills (3.3, 3.6, 3.8, 4.1mm), 7 Drill Stops (3-9mm), 1 Pilot Drill & 1 Bone Graft Condenser  
**#MEIS-BCLBA2 . . . . .988.00 KIT**

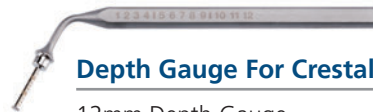

### Depth Gauge For Crestal Sinus Lift Kit

12mm Depth Gauge  
**#MEIS-CL021 . . . . .153.15 EACH**

### Internal Sinus Manipulation Set

#### *Minimally Invasive Sinus Floor Augmentation*

Designed By Dr. Jason M. Yamada

-  Small Rounded Head Bone Graft Spreader & Packer  
**#ISM-1 . . . . . 122.50 EACH**
-  Large Rounded Head Bone Graft Spreader & Packer  
**#ISM-2 . . . . . 122.50 EACH**
-  Sinus Lift Instrument -  
Keep Sharp Working End Against Bony Floor  
**#ISM-3 . . . . . 122.50 EACH**
-  Sinus Lift Instrument -  
Keep Sharp Working End Against Bony Floor  
**#ISM-4 . . . . . 122.50 EACH**
-  Membrane Perforation Repair Instrument  
**#ISM-5 . . . . . 122.50 EACH**

### SPECIAL

### Internal Sinus Manipulation Set



Set Of 5 Instruments With  
**FREE** Stainless Steel Cassette  
**#ISM-KIT**  
**570.00 SET**



Kerrison Rongeurs For Widening The Sinus Window

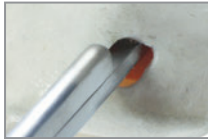

Low Profile Head For Visibility & Safe Access



**Kerrison Rongeur - 4mm Bite**

10cm Long Beak

#KERRISON . . . . . 625.00 EACH

**MOST POPULAR**

**Kerrison Rongeur - 3mm Bite**

8cm Long Beak

#KERRISON-SMALL . . . . . 625.00 EACH

Serrated Tip Sinus Window Bone Tampers

To Precisely Separate Sinus Window From Surrounding Bone

**MOST POPULAR**

**4mm Sinus Window / Bone Tamper**

#BONE-TAMPER-4MM . . . . . 82.50 EACH



**7mm Sinus Window / Bone Tamper**

#BONE-TAMPER-7MM . . . . . 82.50 EACH



**SPECIAL**



Set Of 2 Bone Tampers

#BONE-TAMPER-SET . . . . . 147.00 SET OF 2

Sinus Scoring Diamonds



**Sinus Scoring Diamond-Latch Type**

Fits Latch Type Implant Handpieces

#SINUS-SCORE-DIAM-RA

INDIVIDUALLY . . . . . 18.50 EACH

10 OR MORE . . . . . 16.20 EACH



**Sinus Scoring Diamond-HP Type**

Fits Straight Implant & Oral Surgery Handpieces

#SINUS-SCORE-DIAM-HP

INDIVIDUALLY . . . . . 18.50 EACH

10 OR MORE . . . . . 16.20 EACH

Sinus Lift Instruments

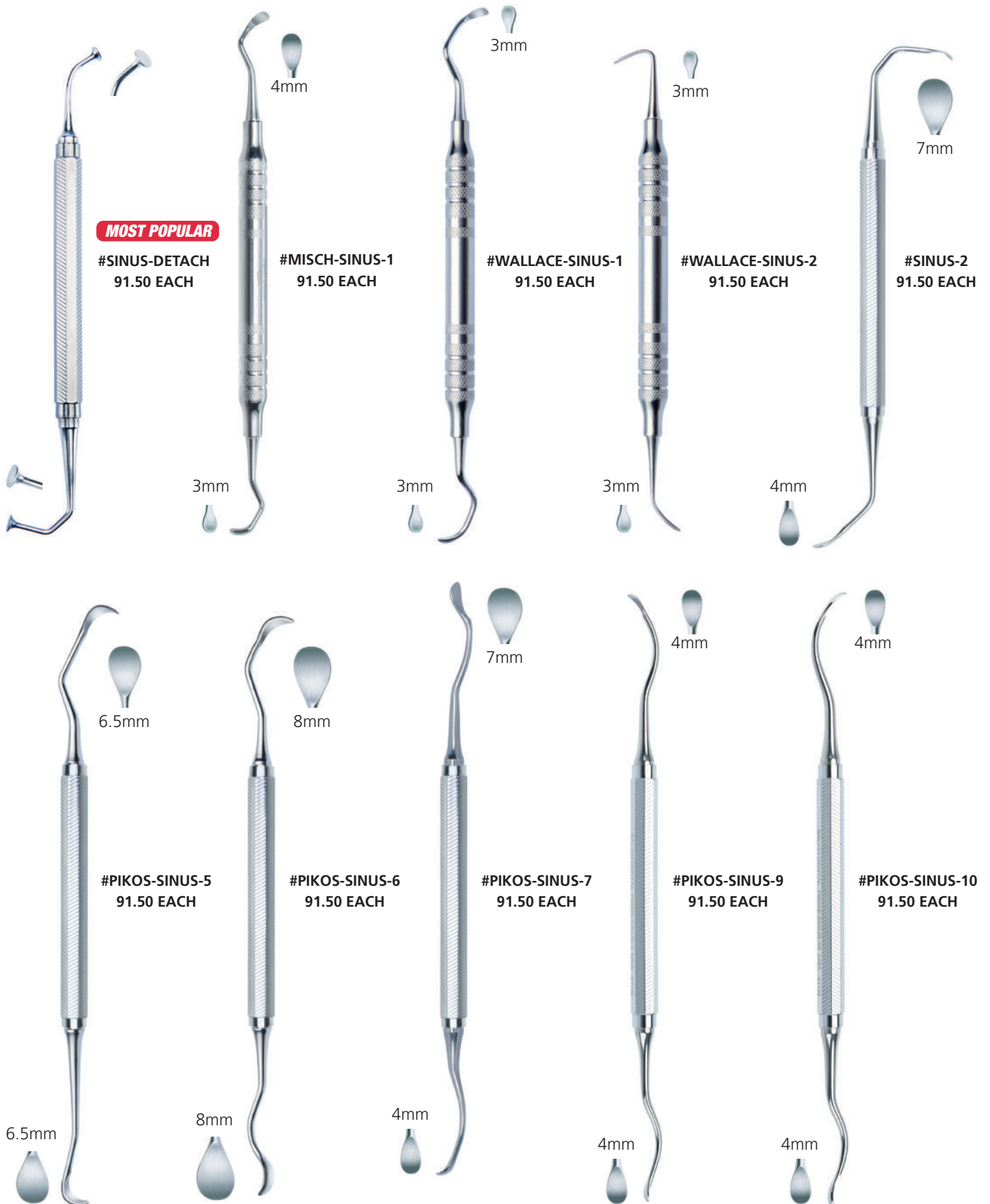

Sinus Lift Instruments

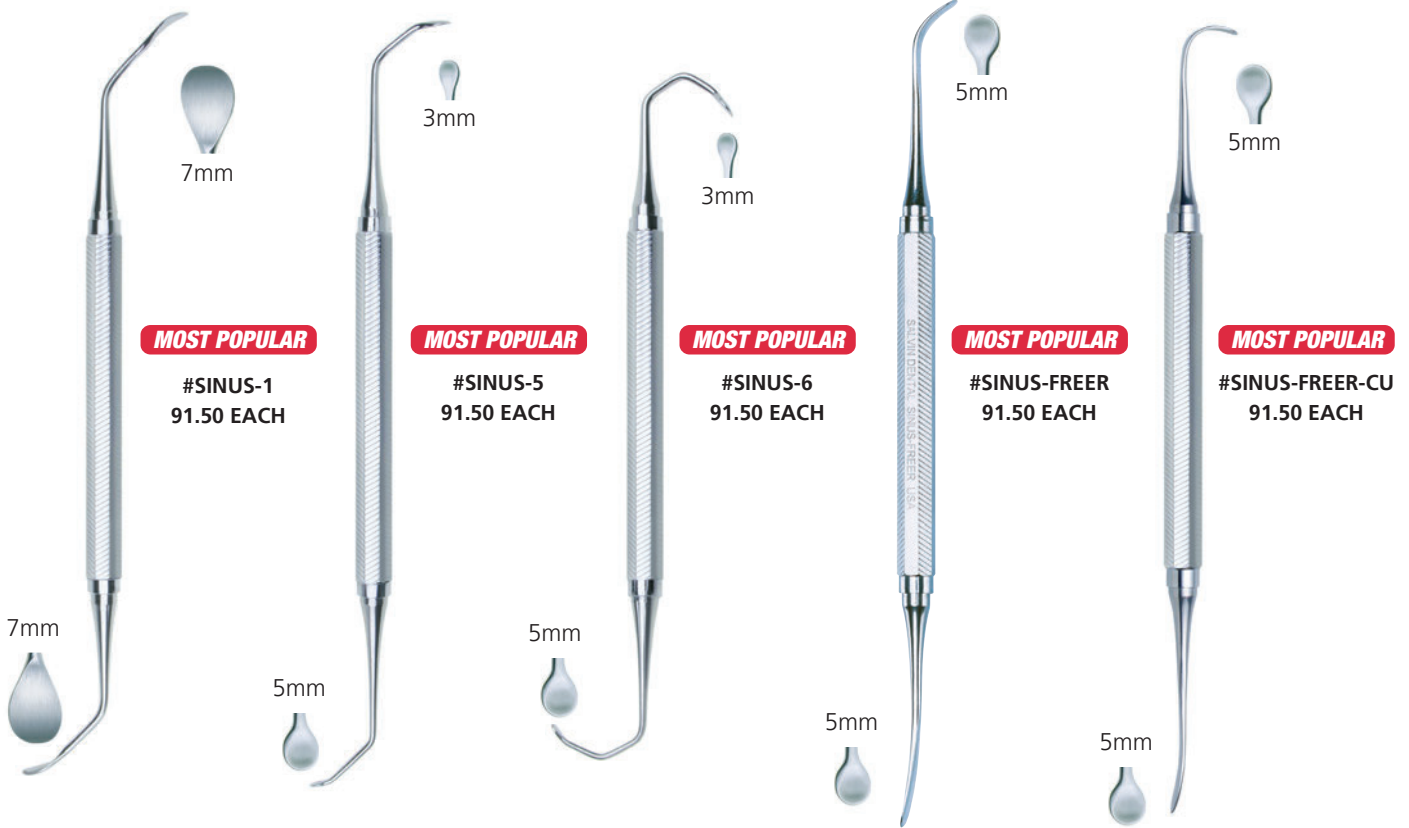

**SPECIAL**

Salvin Basic Sinus Set

**MOST POPULAR**

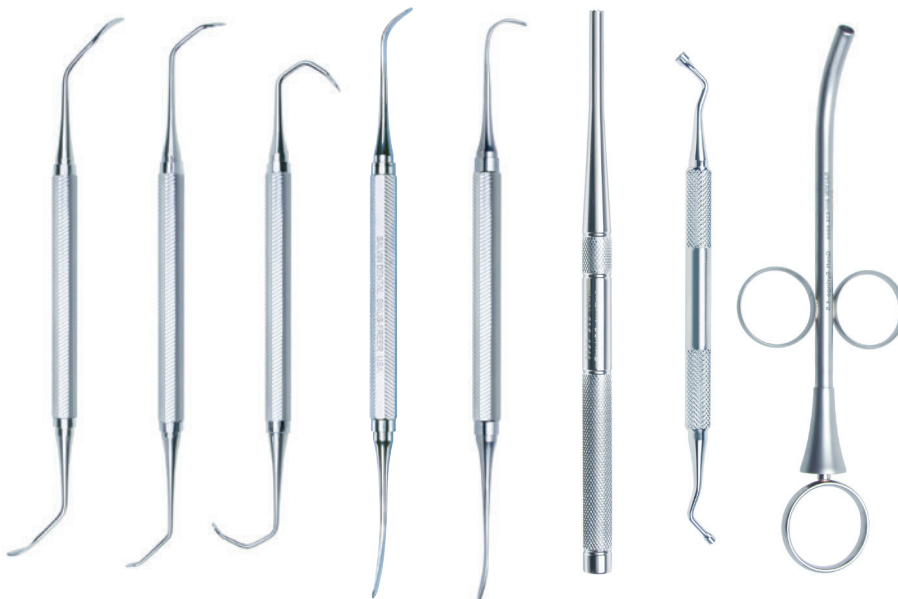

**Basic Set Includes:**

- 4mm Bone Tamper
  - Small Serrated Graft Packer
  - 4.5mm Graft Syringe
  - Salvin Sinus Curette #1
  - Salvin Sinus Curette #5
  - Salvin Sinus Curette #6
  - Salvin Sinus Freer
  - Salvin Sinus Freer Curved
- (Or Your Choice Of Any 5 Currettes)

• Plus **FREE** Cassette  
**#SINUS-KIT-WINDOW**  
**834.00 SET**

Mallets & Chisels



**Cottle Curved Chisels**

Depths Marked At  
6, 9, 12, 14 & 17mm

**MOST POPULAR**

#COTTLE-4 (4MM WIDE)

#COTTLE-6 (6MM WIDE)

INDIVIDUALLY  
..... 129.10 EACH  
3 OR MORE  
..... 122.40 EACH



**Sheehan Osteotomes**

Depths Marked At  
6, 9, 12, 14 & 17mm

#SHEE 2 (2MM WIDE)

**MOST POPULAR**

#SHEE 4 (4MM WIDE)

#SHEE 6 (6MM WIDE)

INDIVIDUALLY  
..... 129.10 EACH  
3 OR MORE  
..... 122.40 EACH

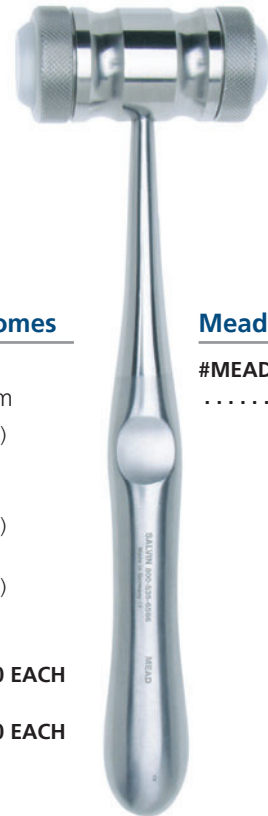

**Mead Mallet**

#MEAD  
..... 161.90 EACH



**TG Perio Chisel**

#PERIO-CHISEL-TG  
..... 99.40 EACH  
3 OR MORE  
..... 93.90 EACH



**MOST POPULAR**

**TG-O Perio Chisel**

#PERIO-CHISEL-TGO  
..... 99.40 EACH  
3 OR MORE  
..... 93.90 EACH



Rongeurs

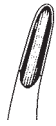

**MOST POPULAR**

**Friedman Rongeur**

#FRIED  
..... 293.00 EACH

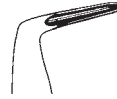

**Micro Friedman  
Right Angle Rongeur**

#MICRO FRIED R  
..... 293.00 EACH



**MOST POPULAR**

**Micro Friedman  
Rongeur**

#MICRO FRIED  
..... 293.00 EACH

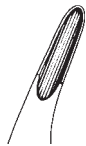

Tip Laser  
Marked At  
1-10mm

**MOST POPULAR**

**Blumenthal Rongeur**

#BLUM  
..... 293.00 EACH



**Blumenthal Rongeur  
Right Angle**

#BLUM-RA  
..... 293.00 EACH



**MOST POPULAR**

**Mini Blumenthal  
Rongeur**

#MINI BLUM  
..... 293.00 EACH

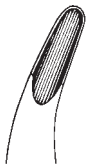

**Mead 1-A Oral Surgery  
Rongeur**

#MEAD-1-A RONG  
..... 293.00 EACH

Kerrison Rongeurs For Widening The Sinus Window



**Kerrison Rongeur - 4mm Bite**

10cm Long Beak

#KERRISON . . . . . 625.00 EACH



**MOST POPULAR**

**Kerrison Rongeur - 3mm Bite**

8cm Long Beak

#KERRISON-SMALL . . . . . 625.00 EACH

Low Profile Head  
For Visibility  
& Safe Access

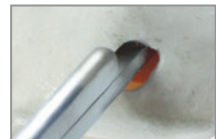

Double Action Rongeurs - Increased Leverage & Effortless Cutting



Double Action Gives You  
A 3:2 Mechanical Advantage



3.5mm Bite

**DOUBLE ACTION**

**MOST POPULAR**

**Beyer Rongeur  
17.8cm Long**

Double Action For Increased Leverage

#BEYER. . . . . 440.00 EACH



5.0mm Bite

**DOUBLE ACTION**

**Ruskin Rongeur  
17.8cm Long**

Double Action For Increased Leverage

#RUSKIN. . . . . 440.00 EACH

**Salvin Bone Manipulation Driver Kit**

- Includes Bone Spreaders, Osteotomes, Ridge Splitter & Bone Pick
- Accepts All Other Latch Type Drills & Instruments
- Compatible With All Implant Systems

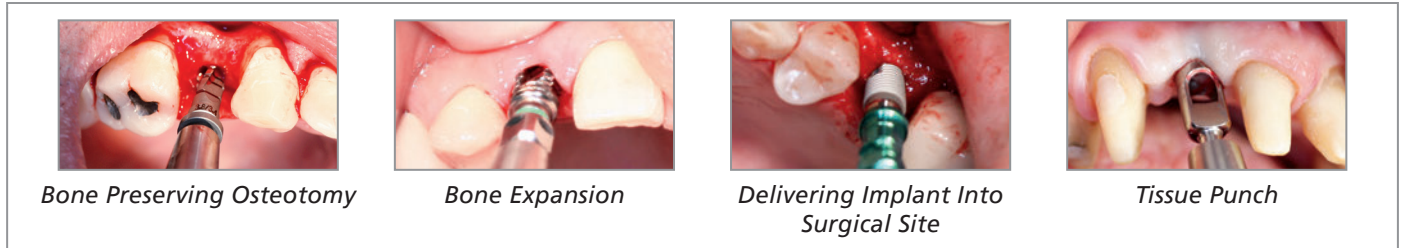

Designed By  
Dr. German L. Murias

**Salvin Bone Manipulation Driver Kit**

- Contains Driver & 10 Tips In Autoclavable Storage Box
- Fits All Latch Type Tips
- Provides Excellent Tactile Feel
- Can Be Used With Implant Drills In Type 2 Or 3 Bone
- Solid Connection Between Parts Prevents Movement

#DRILL-DRIVER-KIT ..... 1885.00 KIT

**Bone Expander Kit**

- Alternative To Osteotomes For The Expansion & Condensing Of The Atrophic Mandible & Maxilla
- Use With Ratchet Wrench Or Low Speed Handpiece
- Improve Stability, Maintain Bone Density & Increase Fixation
- Can Be Used With Implants Up To 16mm Long
- Contains 5 Bone Expanders, 1 Ratchet Wrench, 1 Pilot Drill, 1 Ratchet Wrench Connector, 1 Latch-Type Connector, 1 Thumb Knob, 1 Saw Disc

#BONE-EXPANDER-KIT-2 ..... 729.50 KIT



Bone Spreading Osteotomes For Implant Placement In Soft Bone

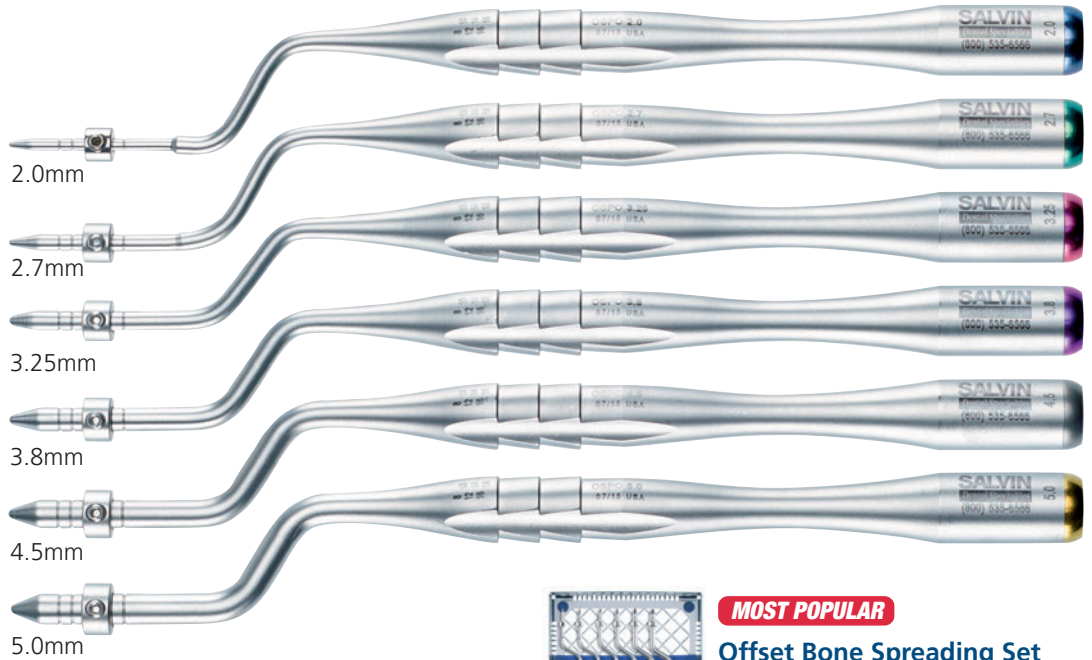
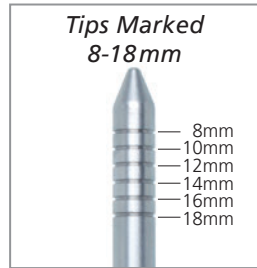

**MOST POPULAR**

**Offset Bone Spreading Set**

- 6 Offset Spreaders With Adjustable Stops
- FREE Stainless Steel Cassette

#OST-SPREAD-OFF-PKG. . . . 891.00 SET



**Straight + Offset Bone Spreading Set**

- 6 Offset Spreaders With Adjustable Stops
- 6 Straight Spreaders With Adjustable Stops
- FREE Stainless Steel Cassette

#OST-SPREAD-BOTH-PKG . . . . . 1668.00 SET



**Straight Bone Spreading Set**

- 6 Straight Spreaders With Adjustable Stops
- FREE Stainless Steel Cassette

#OST-SPREAD-STR-PKG. . . . 891.00 SET



Double Sided Ridge Splitting / Expanding Chisels - Offset

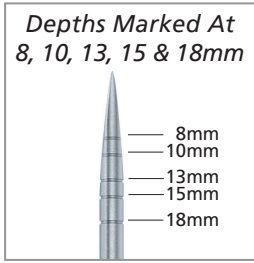

Ridge Splitting Offset Chisel Set

- Set Of 4 Ridge Splitting Offset Chisels
  - Stainless Steel Cassette
- #RIDGE-SPLIT-OFF-SET . . . . . 566.00 SET

Double Sided Ridge Splitting / Expanding Chisels - Straight

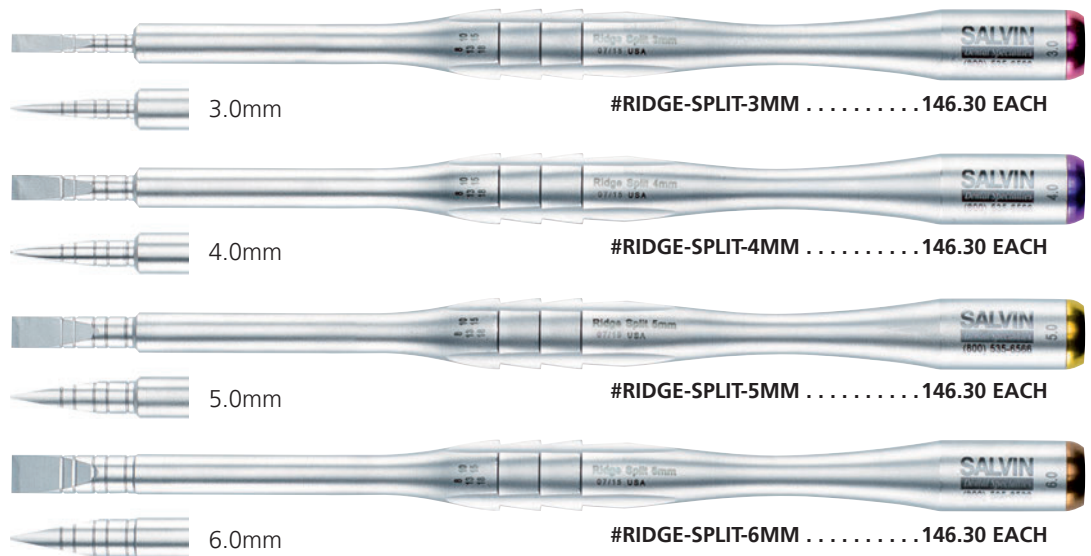
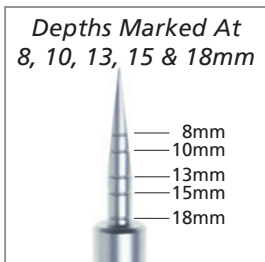

**MOST POPULAR**

Ridge Splitting Chisel Set

- Set Of 4 Ridge Splitting Chisels
  - Stainless Steel Cassette
- #RIDGE-SPLIT-SET . . . . . 566.00 SET

Single Bevel Ridge Splitting / Expanding Chisels

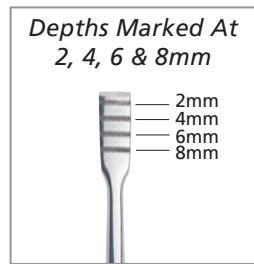

Meisinger Mandibular Bone Spreading Kit

Horizontal Widening Up To 5mm

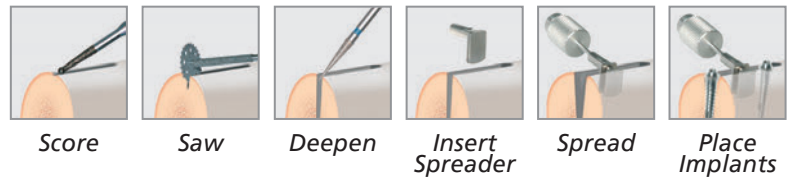

**MOST POPULAR**

Comprehensive Ridge Splitting Kit

3 Spreaders, 5 Burs, 3 Saw Discs, 2 Thumb Drivers & 1 Ratchet  
#CREST-CONTROL . . . . . 1869.95 KIT

Meisinger Maxillary Bone Spreading Kit

Minimally Invasive Alternative To Osteotomes

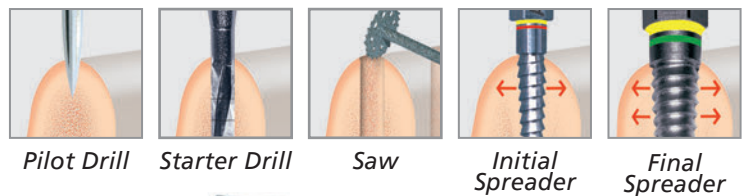

**MOST POPULAR**

Comprehensive Bone Spreading Kit

- Controlled Dilatation Of Horizontally Resorbed Bone Up To 4mm
- 6 Spreaders, 7 Burs, 2 Saw Discs, 1 Adapter & 1 Ratchet

#SPLIT-CONTROL . . . . . 1392.20 KIT

Basic Bone Spreading System

- Controlled Dilatation Of Horizontally Resorbed Bone Up To 4mm
- 3 Spreaders, 2 Burs, 1 Saw Disc, 2 Adapters & 1 Ratchet

#SPLIT-CONTROL-BASIC . . . . . 835.00 KIT

Splitting / Spreading Combination Kit

Mandibular Ridge Splitting + Maxillary Bone Spreading Kit

- Comprehensive Ridge Splitting System Components
- Comprehensive Bone Spreading System Components
- Large Organizing Cassette
- Plus **FREE** Motor Driver Attachments For Spreaders

TOTAL PRICE OF COMPONENTS IS 2705.00 **SAVE 200.00**  
#MEIS-CREST-SPLIT . . . . . 2505.00 KIT



## Tunneling & Vestibular Approach Instrument Set



**Perio Probe**

#TVA-PERIO-PROBE  
 ..... 51.90 EACH



**Perio Elevator #1**

#TVA-PERIO-ELEV-1  
 ..... 107.60 EACH



**Perio Elevator #2**

#TVA-PERIO-ELEV-2  
 ..... 107.60 EACH



**Perio Elevator #3**

#TVA-PERIO-ELEV-3  
 ..... 107.60 EACH



**Tunnel Knife #1**

#TVA-TUNNEL-KNIFE-1  
 ..... 107.60 EACH

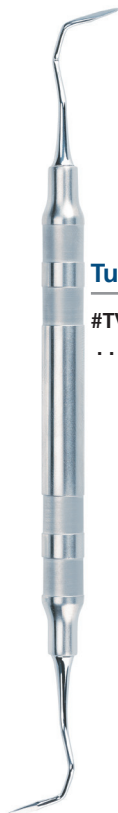

**Tunnel Knife #2**

#TVA-TUNNEL-KNIFE-2  
 ..... 107.60 EACH



**Gingivectomy Knife**

#TVA-GINGI-KNIFE  
 ..... 107.60 EACH



**Flap Prep Instrument #1**

#TVA-FLAP-PREP-1  
 ..... 107.60 EACH



**Flap Prep Instrument #2**

#TVA-FLAP-PREP-2  
 ..... 107.60 EACH



**Perio Chisel**

#TVA-PERIO-CHISEL  
 ..... 107.60 EACH

Tunneling & Vestibular Approach Instrument Set



Tissue Plugger

#TVA-TISSUE-PLUGGER  
..... 107.60 EACH



Tunnel Spoon #1

#TVA-TUNNEL-SPOON-1  
..... 107.60 EACH



Tunnel Spoon #2

#TVA-TUNNEL-SPOON-2  
..... 107.60 EACH



Tunnel Spoon #3

#TVA-TUNNEL-SPOON-3  
..... 107.60 EACH



Micro Blade Handle

#TVA-BLAD-HANDLE  
..... 138.90 EACH

SPECIAL

Tunneling & Vestibular Approach Instrument Set

MOST POPULAR

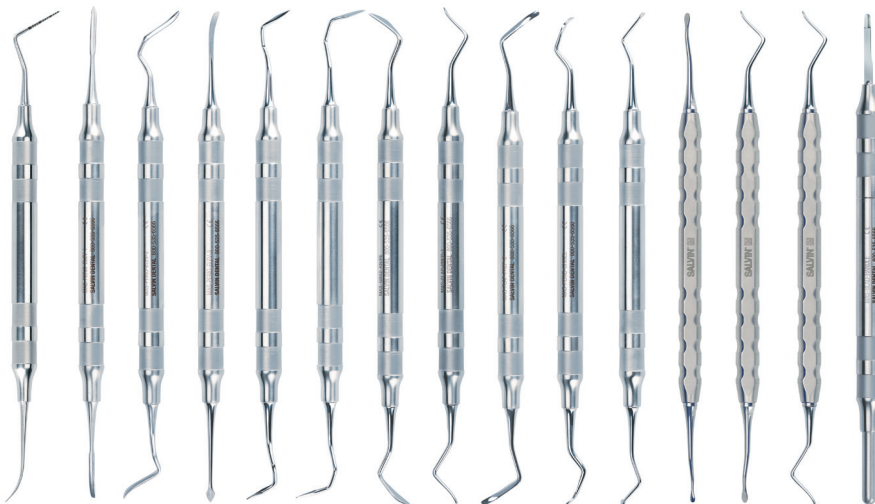

- Perio Probe
  - Perio Elevator #1
  - Perio Elevator #2
  - Perio Elevator #3
  - Tunnel Knife #1
  - Tunnel Knife #2
  - Gingivectomy Knife
  - Flap Prep Instrument #1
  - Flap Prep Instrument #2
  - Perio Chisel
  - Tissue Plugger
  - Tunnel Spoon #1
  - Tunnel Spoon #2
  - Tunnel Spoon #3
  - Micro Blade Handle
  - **FREE** Stainless Steel Cassette
- #TVA-TUNNEL-KIT . . . . 1690.00 SET



Tunneling & Soft Tissue Instruments



**Tunneling Elevator #1**

#TUNNEL-ELEV-1  
.....88.40 EACH



**MOST POPULAR**

**Tunneling Elevator #2**

#TUNNEL-ELEV-2  
.....88.40 EACH



**Tunneling Elevator #3**

#TUNNEL-ELEV-3  
.....88.40 EACH



**PD Miller  
Tunneling Elevator**

#PDMILLER-ELEV-1  
.....88.40 EACH



**Micro Forceps**

#FORCEP-MICRO  
.....115.90 EACH



**Tissue Augmenter**

#TISSUE-AUGMENT  
.....115.90 EACH

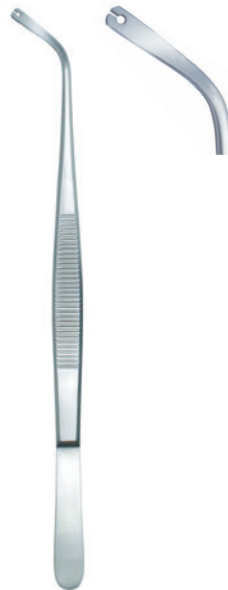

**MOST POPULAR**

**Corn Pliers - Angled**

Suture Forcep With  
"Pass-Through" Hole  
15.4cm  
#CORN-PLIER  
.....91.50 EACH



**MOST POPULAR**

**Suture Pliers**

"Delicate Procedure"  
15.8cm Suture Forcep  
1.6mm Ring Tip  
#SUTURE-PLIER  
.....148.80 EACH

Orban & Hirschfeld For Tunneling



**MOST POPULAR**

**Orban Knife**

#ORBAN  
.....79.70 EACH  
3 OR MORE  
.....75.40 EACH



**MOST POPULAR**

**Orban 1/2 Short**

#ORBAN-1/2-SHORT  
.....79.70 EACH  
3 OR MORE  
.....75.40 EACH



**Orban 1/2 Long**

#ORBAN-1/2-LONG  
.....79.70 EACH  
3 OR MORE  
.....75.40 EACH



**Hirschfeld 16/17 Tunneling File**

Rounded Tip Prevents Puncturing Tissue  
#HIRSCHFELD-16/17-FIL . . . 82.90 EACH  
3 OR MORE . . . . . 77.40 EACH

**SPECIAL**

**Salvin Tunneling Basic Instrument Set #2**

**MOST POPULAR**



**Includes:**

- Tunneling Forcep
- Micro Jacobson Curved N/H
- Tunneling Elevator #1
- Tunneling Elevator #2
- Tunneling Elevator #3
- Orban 1/2 Short
- Orban 1/2 Long
- Hirschfeld 16/17 Tunneling File
- PD Miller Tunneling Elevator
- Younger Good 7/8
- Suture Pliers
- **FREE** Stainless Steel Cassette

#TUNNEL-KIT-2 . . . . . **1710.00 SET**

Micro Surgery Instruments



**MOST POPULAR**

**Rhodes Chisel**

17.2cm  
Back Action  
#RHODES  
..... 97.90 EACH



**MOST POPULAR**

**Micro Elevator #1**

17.2cm  
#MICRO-ELEV-1  
..... 97.90 EACH



**Micro Elevator #2**

17.2cm  
#MICRO-ELEV-2  
..... 97.90 EACH



**Micro Elevator #3**

17.2cm  
#MICRO-ELEV-3  
..... 97.90 EACH



**Micro Elevator #4**

17.2cm  
#MICRO-ELEV-4  
..... 97.90 EACH



**MOST POPULAR**

**Micro Chisel #1**

17.2cm  
#MICRO-CHISEL-1  
..... 97.90 EACH



**Micro Chisel #2**

17.2cm  
#MICRO-CHISEL-2  
..... 97.90 EACH

**SPECIAL**

**Salvin Micro Surgery Set**

**MOST POPULAR**



- Micro Castro Needle Holder Curved
- Micro Adson Tissue Forcep
- Ross Scissors
- Rhodes Chisel
- Micro Chisel #1
- Micro Elevator #1
- Micro Elevator #3
- **FREE** Stainless Steel Cassette
- #MICRO-SURG-KIT-1 . . . . . **1175.00 SET**

**Pikos / Ordonez Soft Tissue Manipulation Instrument Set**

*Ideal For Tunneling & Pocket Flap Procedures*

Collaboratively Designed By Dr. Mike Pikos & Dr. Alvaro Ordonez



**Pikos/Ordonez #1**  
Tunneling Instrument  
#SOFTIMAK-1  
..... 91.50 EACH



**Pikos/Ordonez #2**  
Used For Pocket Flaps  
#SOFTIMAK-2  
..... 91.50 EACH



**Pikos/Ordonez #3**  
Used For Pocket Flaps  
#SOFTIMAK-3  
..... 91.50 EACH



**Pikos/Ordonez #5**  
Used For Pocket Flaps  
#SOFTIMAK-5  
..... 91.50 EACH



**Pikos/Ordonez #6**  
Used For Pocket Flaps  
#SOFTIMAK-6  
..... 91.50 EACH



**Pikos/Ordonez #8**  
Used For Reverse Flap  
#SOFTIMAK-8  
..... 91.50 EACH



**Pikos/Ordonez #7**  
Thin Modified Orban  
#SOFTIMAK-7  
..... 91.50 EACH



**Pikos/Ordonez #4**  
Thin Microperiosteal  
#SOFTIMAK-4  
..... 91.50 EACH



**Pikos/Ordonez Tissue Forcep**  
TC Coated  
#SOFTIMAK-TF-1  
..... 119.50 EACH

**SPECIAL**

**Pikos / Ordonez Soft Tissue Manipulation Set**

**MOST POPULAR**

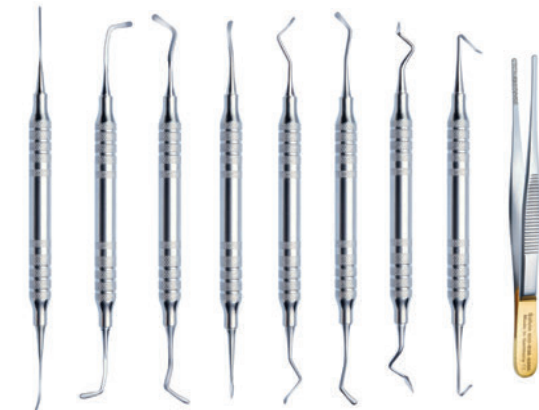

Set Of 9 Instruments With **FREE** Stainless Steel Cassette  
#SOFTIMAK-KIT  
**833.00 SET**



**Tunneling Forceps**

**For Pulling Tissue Graft Through Tunnel**

- Micro Thin For Uninterrupted Passage Through Tunnel
- 75° Angle For All Areas & Applications
- Pressure Limiting Spring Prevents Damage To Graft
- Diamond Coated For Slip Resistance



Guide Through Tunnel To Grasp Tissue Graft



Close Forceps & Pull Graft Through Tunnel



**MOST POPULAR**  
Tunnel Forcep  
Straight

#TUNNEL-FORCEP  
..... 400.00 EACH



Tunnel Forcep  
Curved Left

#TUNNEL-FORCEP-CU-L  
..... 400.00 EACH



Tunnel Forcep  
Curved Right

#TUNNEL-FORCEP-CU-R  
..... 400.00 EACH

**SPECIAL** Set Of 3 Tunnel Forceps  
#TUNNEL-FORCEP-SET-3 ..... 926.00 SET OF 3

**Micro Needle Holders**



**Smooth Tips**  
TUNGSTEN CARBIDE  
FOR 6-0 TO 10-0 SUTURES

SALVIN  
Comfort  
Handle

**Micro Castro Needle Holder**

- 13.3cm - Straight Tips  
#MICRO-CASTRO-STR ..... 516.00 EACH  
13.3cm - Curved Tips  
#MICRO-CASTRO-CUR ..... 516.00 EACH



**Serrated Tips**  
TUNGSTEN CARBIDE  
FOR 5-0 TO 7-0 SUTURES

SALVIN  
Comfort  
Handle

**Micro Needle Holder**

- 13.3cm - Straight Tips  
#MICRO-N-HOLDER-STR ..... 516.00 EACH  
13.3cm - Curved Tip  
#MICRO-N-HOLDER ..... 516.00 EACH



**MOST POPULAR**  
**Smooth Tips**  
TUNGSTEN CARBIDE  
FOR 6-0 TO 10-0 SUTURES

SALVIN  
Comfort  
Handle

**Micro Jacobson Needle Holder**

- 17.8cm - Straight Tips  
#MICRO-JACOBSON-STR ..... 516.00 EACH  
17.8cm - Curved Tips  
#MICRO-JACOBSON-CUR ..... 516.00 EACH

Micro Surgery Instruments



Ross Scissors  
Curved

15cm  
#ROSS.....374.40 EACH  
3 OR MORE .....355.60 EACH



**MOST POPULAR**

Castroviejo Micro Scissors  
Curved

15cm  
#MICRO-CASTRO-SCISS  
.....503.20 EACH



Micro Goldman Fox Scissors  
Curved

11.5cm  
#MICRO-GF-SCISS...141.60 EACH  
3 OR MORE .....135.30 EACH



Extra Thin  
Micro Tip

Extra Thin Micro  
Iris Scissors - Curved

11cm  
#IRIS-THIN-CURVED...118.90 EACH  
3 OR MORE .....110.80 EACH



Micro Adson 1x2  
Tissue Forcep

1x2 Teeth - 0.5mm Tips  
12.1cm  
#MICRO-ADSON-1X2  
.....91.50 EACH  
3 OR MORE .....86.90 EACH



**MOST POPULAR**

Micro Adson Serrated  
Tissue Forcep

0.5mm Serrated Jaws  
12.1cm  
#MICRO-ADSON  
.....91.50 EACH  
3 OR MORE .....86.90 EACH



Bishop Harmon  
Micro Tissue Forcep

1x2 Teeth - 0.3mm Tips  
8.6cm  
#BISHOP-HARMON  
.....141.60 EACH  
3 OR MORE .....135.30 EACH

Periosteal Elevators



**MOST POPULAR**

**Molt 2/4**

#MOLT 2/4  
 ..... 82.30 EACH  
 3 OR MORE  
 ..... 77.70 EACH



**Molt 2 Angled Double-Ended**

#MOLT-2-DE  
 ..... 82.30 EACH  
 3 OR MORE  
 ..... 77.70 EACH



**Molt 4 Angled Double-Ended**

#MOLT-4-DE  
 ..... 82.30 EACH  
 3 OR MORE  
 ..... 77.70 EACH

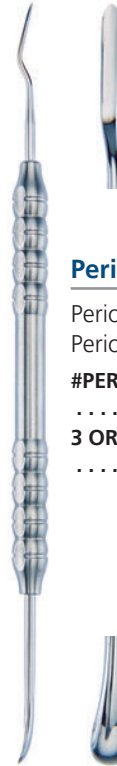

**Periosteal-Tome™**

Periosteal Elevator/  
 Periostome Combo  
 #PERIOSTEAL-TOME  
 ..... 104.40 EACH  
 3 OR MORE  
 ..... 98.90 EACH



**MOST POPULAR**

**Prichard Elevator**

#PRICHARD  
 .....82.30 EACH  
 3 OR MORE  
 .....77.70 EACH



**MOST POPULAR**

**Seldin 23**

#SELDIN  
 ..... 96.90 EACH  
 3 OR MORE  
 ..... 92.70 EACH



**Mini Seldin**

Round Handle  
 For Comfort  
 #MINI-SELDIN  
 ..... 96.90 EACH  
 3 OR MORE  
 ..... 92.70 EACH



**Freer**

#FREER  
 ..... 82.30 EACH  
 3 OR MORE  
 ..... 77.70 EACH



Tip Marked  
 at 1 - 10mm  
 For Spacing

Periosteal Elevators



**MOST POPULAR**

**Buser**

- #BUSER .....82.30 EACH
- 3 OR MORE .....77.70 EACH



**Goldman-Fox Elevator**

- 17cm
- #GOLDMAN-FOX-ELEV .....82.30 EACH
- 3 OR MORE .....77.70 EACH



**Hirschfeld #20**

- #HIRSCHFELD-20 .....82.30 EACH
- 3 OR MORE .....77.70 EACH

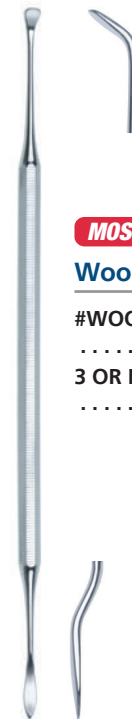

**MOST POPULAR**

**Woodson**

- #WOODSON .....82.30 EACH
- 3 OR MORE .....77.70 EACH



**Quinn-Titanium**

- Gold Titanium Tips For Use Around Implants
- #Q-ELEV-TI .....98.90 EACH
- 3 OR MORE .....92.40 EACH



**MOST POPULAR**

**Quinn**

- #Q-ELEV .....82.30 EACH
- 3 OR MORE .....77.70 EACH



**24G Elevator**

- #EP24G .....82.30 EACH
- 3 OR MORE .....77.70 EACH



**Benque**

- #BENQUE .....82.30 EACH
- 3 OR MORE .....77.70 EACH



Periosteal Elevators



**Molt 4**

#MOLT-4  
 ..... 91.70 EACH  
 3 OR MORE  
 ..... 86.90 EACH



**Molt 2**

#MOLT-2  
 ..... 91.70 EACH  
 3 OR MORE  
 ..... 86.90 EACH



**West**

#WEST  
 ..... 82.60 EACH  
 3 OR MORE  
 ..... 77.90 EACH



**Henahan Retractor Large**

19.5cm  
 #HENAHAN-LARGE  
 ..... 91.70 EACH  
 3 OR MORE  
 ..... 86.90 EACH



**MOST POPULAR**

**Molt 9**

#MOLT 9  
 ..... 82.60 EACH  
 3 OR MORE  
 ..... 77.90 EACH



**Molt 9 With Suture Hole**

#MOLT 9-SUTURE  
 ..... 82.60 EACH  
 3 OR MORE  
 ..... 77.90 EACH



**PCharles**

#PCHARLES  
 ..... 82.60 EACH  
 3 OR MORE  
 ..... 77.90 EACH



**Molt 9 With 15 Aspirating Holes**

#MOLT 9-ASP  
 ..... 82.60 EACH  
 3 OR MORE  
 ..... 77.90 EACH



Sinus Retractors

*Ergonomic Comfort Handle Helps Prevent Hand Fatigue During Long Procedures*



Cheek & Soft Tissue Retractors For Long Complex Surgeries

Scan For 

**60** Second Product Video™



SALVIN  
Comfort  
Handle

Sinus Graft  
Cheek Retractor -  
Left

#SINUS-RETR-L  
.....287.20 EACH



SALVIN  
Comfort  
Handle

Sinus Graft  
Cheek Retractor -  
Right

#SINUS-RETR-R  
.....287.20 EACH



SALVIN  
Comfort  
Handle

**MOST POPULAR**  
Small - Sinus Graft  
Cheek Retractor -  
Universal Right/Left

#SINUS-RETR-SMALL  
.....287.20 EACH

**SPECIAL**

Set Of Left & Right Sinus Graft Cheek Retractors

#SINUS-RETR-SET..... 504.00 SET OF 2



Misch Sinus Retractor

Designed By Dr. Carl Misch

#MISCH-SINUS-RETRACT. ....91.50 EACH



Dog Bone Sinus Retractor - 18cm

Sinus Flap Retractor

#DOG-BONE.....63.50 EACH

Retractors



**MOST POPULAR**  
**Implant Retractor**  
Use As Upper Or Lower  
Vestibular Retractor  
#IMPLANT-RETRACT  
..... 185.80 EACH

**Implant Retractor  
Ergonomic Handle**  
Use As Upper Or Lower  
Vestibular Retractor  
#IMPLANT-RETRACT-ERGO  
..... 238.40 EACH



**Molt Mouth Gag**  
#MOLT GAG ..... 237.80 EACH

**Molt Mouth Gag - Small**  
#MOLT-GAG-SMALL  
..... 237.80 EACH



**Replacement Guards  
For Molt Mouth Gag**  
Autoclavable Silicone Rubber  
#MOLT-GAG-GUARDS ..... 14.40 SET OF 2



**MOST POPULAR**  
**Plastic Cheek Retractor  
Single Handle  
Autoclavable**  
#CHEEK-SINGLE  
SET OF 2 ..... 36.70 SET  
2 OR MORE SETS ..... 33.90 SET



**Plastic Cheek Retractor  
Double Ended  
Autoclavable**  
#CHEEK  
SET OF 2 ..... 55.10 SET  
2 OR MORE SETS ..... 51.40 SET



**Orringer Retractor**  
Spring Steel Flexes  
For Comfortable Fit  
#ORRINGER ..... 85.60 EACH  
2 OR MORE ..... 79.90 EACH



**Orringer Retractor-Small**  
Spring Steel Flexes  
For Comfortable Fit  
#ORRINGER-SMALL . . . 85.60 EACH  
2 OR MORE ..... 79.90 EACH

Retractors



**MOST POPULAR**

**Weider Tongue Retractor**

44mm Wide At Tip

#WEIDER . . . . . 79.60 EACH  
2 OR MORE . . . . . 73.80 EACH



**Weider Tongue Retractor - Small**

31mm Wide At Tip

#WEIDER-SMALL . . . . . 79.60 EACH  
2 OR MORE . . . . . 73.80 EACH



**Salvin Zygoma Retractor**

- Increases Field Of Vision
- Directs The Drilling
- Prevents Perforation Of The Orbit
- Protects Soft Tissue While Drilling Superior Cortex

#ZAGA-2 . . . . . 204.00 EACH



**Laster 3rd Molar Retractor**

#LASTER-RETRACT  
INDIVIDUALLY . . . . . 76.90 EACH  
2 OR MORE . . . . . 72.80 EACH

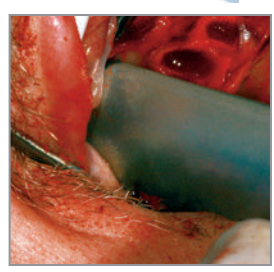
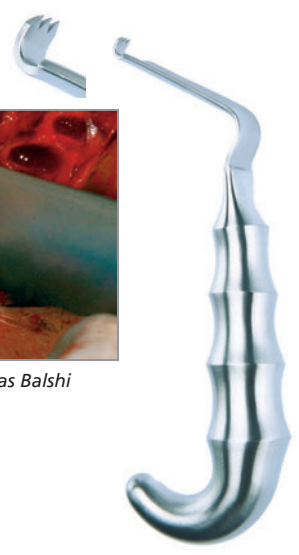

Photo: Dr. Thomas Balshi

**SALVIN**  
Comfort  
Handle



**Balshi Zygomatic Retractor**

Designed By Dr. Thomas Balshi  
#BALSHI-ZYGO-RETRACT. . . . . 187.30 EACH

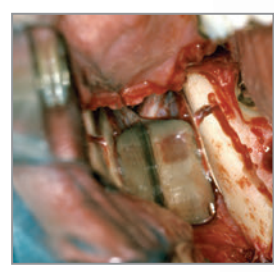

Photo: Dr. Michael Pikos

**SALVIN**  
Comfort  
Handle

**MOST POPULAR**



**Pikos Ramus Retractor**

Designed By Dr. Michael Pikos  
16mm Wide At Tip  
#PIKOS-RETRACTOR . . . . . 187.30 EACH



Retractors



**Cawood-Minnesota Retractor**

#CAWOOD-RETRACT  
INDIVIDUALLY . . . . . 41.10 EACH  
2 OR MORE . . . . . 37.40 EACH



**MOST POPULAR**

**Minnesota Retractor**

#MINN  
INDIVIDUALLY . . . . . 41.10 EACH  
2 OR MORE . . . . . 37.40 EACH



**SALVIN**  
**Comfort**  
**Handle**

**Minnesota Retractor Ergonomic Handle**

#MINN-ERGO  
INDIVIDUALLY . . . . . 135.40 EACH  
2 OR MORE . . . . . 125.50 EACH



**MOST POPULAR**

**Columbia Retractor**

Excellent For Surgery & Photography  
#COL RETR . . . . . 51.70 EACH  
2 OR MORE . . . . . 47.90 EACH



**Austin Retractor**

#AUSTIN-RETRACTOR . . . . . 69.70 EACH



*Easily Bent By Hand  
To Desired Shape*



**Bendable Retractor Stainless Steel**

20cm Long x 18mm Wide  
#RETRACTOR-BENDABLE . . . . . 55.80 EACH

Retractors



**Henahan Retractor Large**

19.5cm  
#HENAHAN-LARGE ..... 96.90 EACH  
#3 OR MORE ..... 91.80 EACH



**MOST POPULAR**

**Seldin 23**

#SELDIN ..... 96.90 EACH  
#3 OR MORE ..... 91.80 EACH



**Mini Seldin**

Round Handle For Comfort  
#MINI-SELDIN ..... 96.90 EACH  
#3 OR MORE ..... 91.80 EACH



**MOST POPULAR**

**Dual View Photo Mirror**

View Buccal, Occlusal & Lingual Surfaces  
At Once  
#PHOTO-DUALVIEW ..... 102.90 EACH



**Latexfree**

**MOST POPULAR**

**Autoclavable Silicone Mouth Props**

Autoclavable To 275°F Or 134°C  
Dry Heat To 350°F Or 160°C  
#MOUTH-PROP-CHILD  
SET OF 2 ..... 39.80 SET  
2 OR MORE SETS ..... 36.70 SET  
#MOUTH-PROP-ADULT  
SET OF 2 ..... 39.80 SET  
2 OR MORE SETS ..... 36.70 SET

Tungsten Carbide Tipped Needle Holders  
For Larger Needle 3-0 & 4-0 Sutures



**Designed For 3-0 To 4-0 Sutures**  
Accommodates Larger Needles Without  
Damaging The Locking Clasp & Instrument Tip



**Serrated Tips**  
TUNGSTEN CARBIDE  
FOR 3-0 TO 4-0 SUTURES

**MOST POPULAR**  
Castroviejo Needle Holder  
Accommodates 3-0 To 4-0 Sutures

Spring Handle For Precise Control  
14cm  
#CASTRO-3.0-4.0 . . . . . 451.90 EACH



**Serrated Tips**  
TUNGSTEN CARBIDE  
FOR 3-0 TO 4-0 SUTURES

Jacobson Needle Holder  
Accommodates 3-0 To 4-0 Sutures

Spring Handle For Precise Control  
17.8cm  
#JACOBSON-3.0-4.0 . . . . . 533.50 EACH

Tungsten Carbide Tipped Needle Holder With Side Cutting Scissors

Scissor On Side For Faster Suturing Without Changing Instruments



TUNGSTEN CARBIDE  
FOR 2-0 TO 4-0 SUTURES



Hold Suture Taut In Slot...

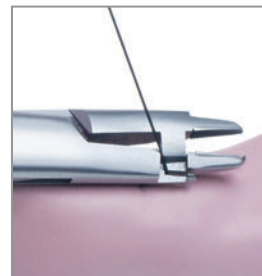

...Slide Down To Knot...

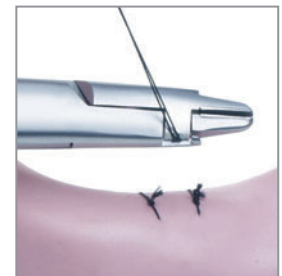

...Squeeze To Cut,  
Leaving A 2mm Tag

Side Cutting Mayo Hegar 6"

Carbide Tipped With Scissors  
15.3cm  
#SIDE CUT MAYO . . . . . 335.00 EACH  
3 OR MORE . . . . . 318.70 EACH

Tungsten Carbide Tipped Castroviejo & Micro Needle Holders



BUYER'S GUIDE - CARBIDE TIPPED NEEDLE HOLDERS	
▶	Superior Grip Holds Needle Without Slipping
▶	Less Hand Fatigue & Cramping During Long Surgeries
▶	Last 4-6 Times Longer Than Standard Instruments
▶	Can Be Economically Re-Tipped



**Castroviejo Needle Holder**

Spring Handle For Precise Control - 14cm  
 #CASTRO ..... 451.90 EACH  
 #CASTRO-CURVED ..... 451.90 EACH



**Jacobson Needle Holder**

Spring Handle For Precise Control - 17.8cm  
 #JACOBSON ..... 533.50 EACH  
 #JACOBSON-CURVED ..... 533.50 EACH



**Featherlite Snagless Needle Holder**

17.8cm - Straight Tips  
 #NH-ROUND-7-TCL-R ..... 533.50 EACH



**Round Jacobson Needle Holder**

Spring Handle For Precise Control - 17.8cm  
 #JACOBSON-ROUND ..... 533.50 EACH



**Micro Jacobson Needle Holder**

17.8cm - Straight Tips  
 #MICRO-JACOBSON-STR ..... 533.50 EACH  
 17.8cm - Curved Tips  
 #MICRO-JACOBSON-CUR ..... 533.50 EACH



**Micro Castroviejo Needle Holder**

13.3cm - Straight Tips  
 #MICRO-CASTRO-STR ..... 533.50 EACH  
 13.3cm - Curved Tips  
 #MICRO-CASTRO-CUR ..... 533.50 EACH



Tungsten Carbide Tipped Needle Holders



**Serrated Tips**  
**TUNGSTEN CARBIDE**  
 FOR 3-0 TO 5-0 SUTURES

**Crile Wood Needle Holder - Curved**

15.3cm  
 #CRILE-CURVED . . . . . 195.70 EACH  
 3 OR MORE . . . . . 187.50 EACH



**Serrated Tips**  
**TUNGSTEN CARBIDE**  
 FOR 3-0 TO 5-0 SUTURES

**MOST POPULAR**  
**Crile Wood Needle Holder**

15.3cm  
 #CRILE . . . . . 195.70 EACH  
 3 OR MORE . . . . . 187.50 EACH



**Serrated Tips**  
**TUNGSTEN CARBIDE**  
 FOR 2-0 TO 4-0 SUTURES

**MOST POPULAR**  
**Mayo Hegar Needle Holder**

15.3cm  
 #MAYO HEGAR . . . . . 195.70 EACH  
 3 OR MORE . . . . . 187.50 EACH



**Serrated Tips**  
**TUNGSTEN CARBIDE**  
 FOR 3-0 TO 5-0 SUTURES

**Crile Wood Needle Holder - Long**

17.8cm  
 For Suturing Extracted 3rd Molar Sockets  
 #CRILE-LONG . . . . . 195.70 EACH  
 3 OR MORE . . . . . 188.50 EACH



**Serrated Tips**  
**TUNGSTEN CARBIDE**  
 FOR 3-0 TO 5-0 SUTURES

**Mathieu Needle Holder**

"Squeeze Through" Quick Release  
 12.7cm  
 #MATHIEU . . . . . 266.90 EACH  
 3 OR MORE . . . . . 255.70 EACH



**Serrated Tips**  
**TUNGSTEN CARBIDE**  
 FOR 5-0 TO 7-0 SUTURES

**SALVIN**  
**Comfort**  
**Handle**

**Castroviejo Needle Holder**  
**Straight Handle**

12.7cm  
 #CASTRO-STR-HANDLE . . . . . 498.40 EACH



**Sutures On Pages 30-33**

Tungsten Carbide Tipped Needle Holders



Serrated Tips  
TUNGSTEN CARBIDE  
FOR 4-0 TO 6-0 SUTURES

**MOST POPULAR**

Par Perio Needle Holder

12.7cm  
Delicate Serrated

#PAR . . . . . 197.80 EACH  
3 OR MORE . . . . . 185.40 EACH

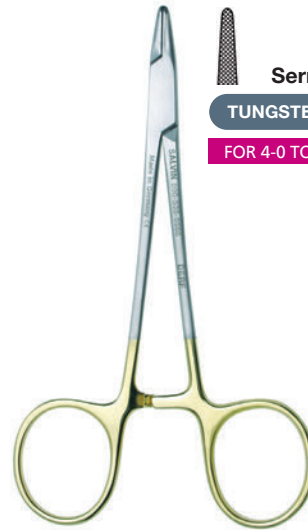

Serrated Tips  
TUNGSTEN CARBIDE  
FOR 4-0 TO 6-0 SUTURES

Derf Needle Holder

12.1cm

#DERF . . . . . 197.80 EACH  
3 OR MORE . . . . . 185.40 EACH



Serrated Tips  
TUNGSTEN CARBIDE  
FOR 3-0 TO 5-0 SUTURES

Olsen Hegar Scissors/Needle Holder

14cm

#OH 5 . . . . . 231.80 EACH  
3 OR MORE . . . . . 222.50 EACH



Serrated Tips  
TUNGSTEN CARBIDE  
FOR 3-0 TO 5-0 SUTURES

Olsen Hegar Scissors/Needle Holder

16.5cm

#OH 6 . . . . . 231.80 EACH  
3 OR MORE . . . . . 222.50 EACH

Surgical & Suture Scissors



**Goldman Fox 12.7cm**

Serrated For Slip-Free Cutting  
 #GF SCISS. . . . . 105.40 EACH  
 3 OR MORE . . . . . 99.90 EACH



**MOST POPULAR**

**LaGrange 11.5cm**

Serrated For Slip-Free Cutting  
 #LAGRANGE. . . . . 105.40 EACH  
 3 OR MORE . . . . . 99.90 EACH



**Iris Scissors Straight 11.5cm**

#IRIS-SCISS. . . . . 74.30 EACH  
 3 OR MORE . . . . . 70.40 EACH



**MOST POPULAR**

**Iris Scissors Curved 11.5cm**

#IRIS-SCISS-CURVED . . . . . 74.30 EACH  
 3 OR MORE . . . . . 70.40 EACH



**Long Suture Scissors 15cm**

Hooked End To Lift Suture  
 #LONG . . . . . 138.70 EACH  
 3 OR MORE . . . . . 130.60 EACH



**Littauer Angled Suture Scissors 11.5cm**

Hooked End To Lift Suture  
 #LITTAUER-ANGLED . 111.10 EACH  
 3 OR MORE . . . . . 104.90 EACH



**MOST POPULAR**

**Littauer Suture Scissors 11.5cm**

Hooked End To Lift Suture  
 #LITTAUER. . . . . 88.90 EACH  
 3 OR MORE . . . . . 83.30 EACH



**Metzenbaum-Mayo Dissecting Scissors 14.5cm**

Blunt Tip To Dissect Tissue  
 #METZ-5. . . . . 101.20 EACH  
 3 OR MORE . . . . . 94.10 EACH

SuperCut Serrated Scissors Cut Effortlessly Through Tissue Or Suture

BUYER'S GUIDE - SUPERCUT SCISSORS

- ▶ Razor Sharp Specially Machined Blades Mesh Perfectly To Provide Superior Shearing Force At The Tips
- ▶ Micro Serrations On Lower Blade Grip Tissue For Slip-Free Cutting



SUPERCUT

Goldman Fox Scissors  
13.2cm Curved

#SC GF SCISS . . . . .137.90 EACH  
3 OR MORE . . . . .131.10 EACH



Double Curved

MOST POPULAR

SUPERCUT

LaGrange Scissors  
11.5cm Double Curved

#SC-LAGRANGE . . .137.90 EACH  
3 OR MORE . . . . .131.10 EACH



MOST POPULAR

SUPERCUT

Iris Scissors  
11cm Curved

#SC IRIS CU . . . . .137.90 EACH  
3 OR MORE . . . . .131.10 EACH

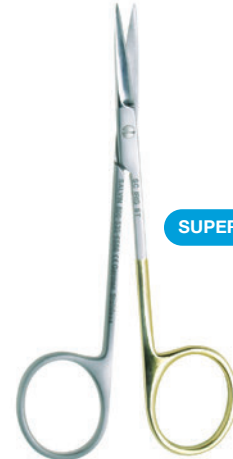

SUPERCUT

Iris Scissors  
11cm Straight

#SC IRIS ST . . . . .137.90 EACH  
3 OR MORE . . . . .131.10 EACH

SALVIN Black Kryptonite™ Ceramic Coated Serrated Surgical Scissors

BUYER'S GUIDE - SALVIN BLACK KRYPTONITE™ SCISSORS

- ▶ Long Lasting, Razor Sharp Precise Cutting
- ▶ Lasts 4-6 Times Longer Than Conventional Scissors
- ▶ Non-Glare Finish For Better Tissue Visibility



SALVIN  
Black  
Kryptonite™

Goldman Fox Scissors  
12.5cm Curved

#Kryp-GF-SCISS . . . 252.10 EACH  
3 OR MORE . . . . .239.60 EACH



Double Curved

SALVIN  
Black  
Kryptonite™

LaGrange Scissors  
11.5cm Double Curved

#Kryp-LAGRANGE . . .252.10 EACH  
3 OR MORE . . . . .239.60 EACH



MOST POPULAR

SALVIN  
Black  
Kryptonite™

Iris Scissors  
11.5cm Curved

#Kryp-IRIS-CU . . . .252.10 EACH  
3 OR MORE . . . . .239.60 EACH



MOST POPULAR

SALVIN  
Black  
Kryptonite™

Castroviejo Micro Scissors  
12cm Curved

#Kryp-CASTRO . . . .406.50 EACH  
3 OR MORE . . . . .378.80 EACH



Surgical & Suture Scissors



**Locklin Scissors Angled  
15.5cm**

Serrated For Slip-Free Cutting  
 #LOCKLIN . . . . . 137.90 EACH  
 3 OR MORE . . . . . 131.10 EACH



**Wagner Scissors Angled  
11.5cm**

#WAGNER-SCISS-ANGLED  
 . . . . . 115.20 EACH  
 3 OR MORE . . . . . 109.70 EACH



**Kelly Curved 15.9cm**

Serrated For Slip-Free Cutting  
 #KELLY CURV . . . . . 104.60 EACH  
 3 OR MORE . . . . . 97.20 EACH



**MOST POPULAR  
Dean 17.2cm**

Serrated For Slip-Free Cutting  
 #DEAN . . . . . 137.90 EACH  
 3 OR MORE . . . . . 131.10 EACH

**Featherlite Micropoint Scissors**

*Takes The "Wince" Out Of Suture Removal,  
Even In Sensitive Tissue*



**MOST POPULAR**

**Featherlite 14cm Curved**

#F-LITE5CURV . . . . . 325.00 EACH  
 3 OR MORE . . . . . 308.30 EACH

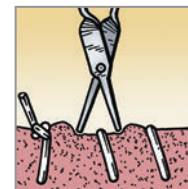
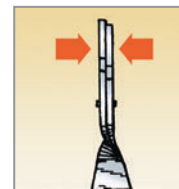

*Opposing Spring Tips Maintain Force  
Between Blades For Incredible  
Cutting Without Pinching Tissue*

**Suture Scissors / Suture Forcep Combination Instrument**

*Cut & Remove Suture With One Instrument*



#SUT-REM-FORCEP . . . . . 325.00 EACH  
 3 OR MORE . . . . . 308.30 EACH



*Engage Suture On Right  
Side Of Knot...*

*...Cut, Squeeze & Pull  
To Remove Suture...*

Periodontal Knives & Surgical Files



**MOST POPULAR**

**Orban Knife**

#ORBAN  
.....79.70 EACH  
3 OR MORE  
.....75.40 EACH



**MOST POPULAR**

**Orban 1/2 Short**

17.2cm  
#ORBAN-1/2-SHORT  
.....79.70 EACH  
3 OR MORE  
.....75.40 EACH



**Orban 1/2 Long**

Extended Length For  
Tunneling Procedures  
17.2cm  
#ORBAN-1/2-LONG  
.....79.70 EACH  
3 OR MORE  
.....75.40 EACH



**Kirkland Knife**

#KIRKLAND  
.....79.70 EACH  
3 OR MORE  
.....75.40 EACH

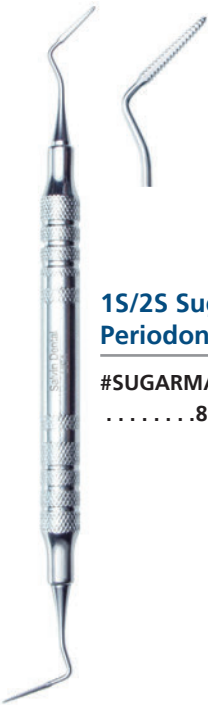

**1S/2S Sugarman  
Periodontal File**

#SUGARMAN-1S/2S  
.....83.10 EACH



**MOST POPULAR**

**3S/4S Sugarman  
Periodontal File**

#SUGARMAN-3S/4S  
.....83.10 EACH



**Hirschfeld 16/17  
Tunneling File**

Rounded Tip  
Prevents Puncturing  
Tissue During  
Tunneling Procedures  
#HIRSCHFELD-16/17-FIL  
..... 83.10 EACH

Perio Curettes



**MOST POPULAR**

**Prichard 1/2  
Universal  
Perio Curette**

#PRICHARD-1/2  
..... 44.20 EACH  
3 OR MORE  
..... 40.90 EACH



**Kramer #3  
Universal  
Perio Curette**

#KRAMER-3  
..... 44.20 EACH  
3 OR MORE  
..... 40.90 EACH

Bone Files



**Bone File #10**

#FIL10..... 83.50 EACH



**Bone File #12**

#FIL12..... 83.50 EACH



**MOST POPULAR**

**Bone File #12CA**

#FIL-12CA..... 83.50 EACH

Syringes & Needle Capper



**MOST POPULAR**

**Aspirating Syringe CW Type**

Works With Standard 1.8cc Cartridges

#SYRINGE CW . . . . . 46.80 EACH  
3 OR MORE . . . . . 43.90 EACH



**Petite Aspirating Syringe**

More Comfort & Control For Smaller Hands

Works With Standard 1.8cc Cartridges  
#SYRINGE-PETITE. . . . . 49.10 EACH  
3 OR MORE . . . . . 45.90 EACH



**Aspirating Syringe A Type**

Works With Standard 1.8cc Cartridges

#SYRINGE A . . . . . 43.90 EACH  
3 OR MORE . . . . . 40.10 EACH



**Needle Capper**

#NEEDLE CAPPER. . . . . 30.20 EACH  
3 OR MORE . . . . . 27.90 EACH



**Intraligamentary Syringe**

- Positive Pressure Design Creates Extra Leverage Without Fatigue
- One Complete Trigger Squeeze Delivers 0.2cc
- Uses Standard Carpules

#NTRALIG. . . . . 470.00 EACH



**Palatal Anesthesia Device**

- Uses Pressure Anesthesia & Gate Control Theory To Reduce Or Eliminate Palatal Injection Pain
- Double-Ended For Right & Left Palatal Injections

#PAD. . . . . 77.10 EACH  
3 OR MORE . . . . . 73.40 EACH

Tissue Forceps



**MOST POPULAR**

**Adson Long 1x2 Tissue Forceps**

1x2 Teeth  
15cm

#ADSON-LONG-1X2  
..... 73.50 EACH  
3 OR MORE  
..... 68.40 EACH



**MOST POPULAR**

**Adson Long Serrated Tissue Forceps**

Serrated Teeth  
15cm

#ADSON-LONG-SERR  
..... 73.50 EACH  
3 OR MORE  
..... 68.40 EACH



**Adson Curved Serrated Tissue Forceps**

Serrated Teeth  
12cm

#ADSON-SERR-CURV  
..... 73.50 EACH  
3 OR MORE  
..... 68.40 EACH



**Debakey Atraumatic Tissue Forcep - Straight**

Serrated Teeth  
16cm

#DEBAKEY-STRAIGHT  
..... 129.30 EACH  
3 OR MORE  
..... 123.50 EACH



**Debakey Atraumatic Tissue Forcep - Curved**

Serrated Teeth  
16cm

#DEBAKEY-CURVED  
..... 129.30 EACH  
3 OR MORE  
..... 123.50 EACH



**Chalazion Mucocele Forcep**

12mm x 16mm Ring  
8.5cm Length

#CHALAZION  
..... 179.40 EACH  
3 OR MORE  
..... 170.90 EACH



Tissue Forceps



**MOST POPULAR**

**Adson 1x2  
Tissue Forceps**

1x2 Teeth  
12cm

#ADSON 1X2

.....70.20 EACH

3 OR MORE

.....66.10 EACH

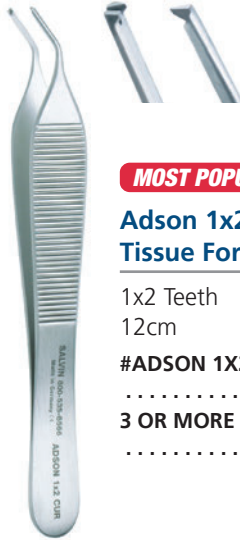

**MOST POPULAR**

**Adson 1x2 Curved  
Tissue Forceps**

1x2 Teeth  
12cm

#ADSON 1X2 CUR

.....73.60 EACH

3 OR MORE

.....68.50 EACH



**MOST POPULAR**

**Micro Adson  
Serrated  
Tissue Forcep**

0.5mm Serrated  
12cm

#MICRO-ADSON

.....91.80 EACH

3 OR MORE

.....87.30 EACH



**Adson 7x7  
Tissue Forceps**

7x7 Teeth  
12cm

#ADSON-7X7

.....91.10 EACH

3 OR MORE

.....86.60 EACH



**Adson 7x7 Curved  
Tissue Forceps**

7x7 Teeth  
12cm

#ADSON-7X7-CURVED

.....91.10 EACH

3 OR MORE

.....86.60 EACH



**Dressing/Tissue  
Forcep**

Serrated Tip  
15.2cm

#DRESS-FORCEP-6

.....56.90 EACH

3 OR MORE

.....52.30 EACH



**Cotton Plier**

Serrated Tip  
15cm

#COTPLI

.....38.80 EACH

3 OR MORE

.....36.40 EACH

Tissue Forceps



**Gerald 1x2**

Delicate Tissue Forceps  
1x2 Teeth  
18cm

#GERALD 1X2  
.....90.20 EACH  
3 OR MORE  
.....85.30 EACH



**Gerald Serrated**

Delicate Tissue Forceps  
Serrated Teeth  
18cm

#GERALD  
.....90.20 EACH  
3 OR MORE  
.....85.30 EACH



**MOST POPULAR**

**Gerald Serrated Straight**

Delicate Tissue Forceps  
Serrated Teeth  
18cm

#GERALD-STRAIGHT  
.....90.20 EACH  
3 OR MORE  
.....85.30 EACH



**MOST POPULAR**

**Gerald 1x2 Teeth Straight**

Delicate Tissue Forceps  
1x2 Teeth  
18cm

#GERALD-1X2-STRAIGHT  
.....90.20 EACH  
3 OR MORE  
.....85.30 EACH

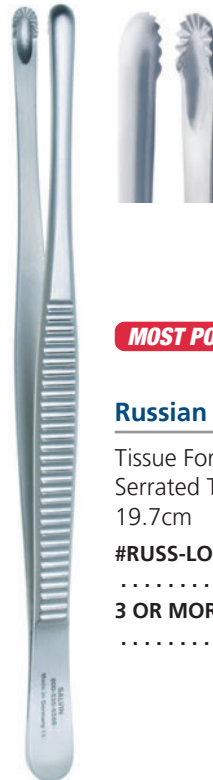

**MOST POPULAR**

**Russian Long**

Tissue Forceps  
Serrated Tip  
19.7cm

#RUSS-LONG  
.....87.20 EACH  
3 OR MORE  
.....83.10 EACH



**Russian**

Tissue Forceps  
Serrated Tip  
15.2cm

#RUSS  
.....79.50 EACH  
3 OR MORE  
.....75.20 EACH

Tissue Forceps



**Adson Titanium Curved Tissue Forceps**

Serrated Teeth  
12cm  
#ADSON-TI-CURVED  
..... 246.20 EACH  
3 OR MORE  
..... 233.90 EACH



**MOST POPULAR**

**Adson Carbide Tipped Tissue Forcep**

Serrated Carbide Tips For Atraumatic Grasp Of Tissue  
12cm  
#ADSON TC  
..... 173.80 EACH  
3 OR MORE  
..... 167.20 EACH



**TC Gripper Carbide Tipped Tissue Forcep**

Serrated Carbide Tips For Atraumatic Grasp Of Tissue  
14.5cm  
#TC GRIPPER  
..... 182.70 EACH  
3 OR MORE  
..... 173.60 EACH



**TC Gripper Long Carbide Tipped Tissue Forcep**

Serrated Carbide Tips For Atraumatic Grasp Of Tissue  
18cm  
#TC-GRIPPER-LONG  
..... 182.70 EACH  
3 OR MORE  
..... 173.60 EACH

Specialty Suturing Forceps



**MOST POPULAR**

**Corn Pliers - Angled**

Suture Forcep With "Pass-Through" Hole  
15.4cm  
#CORN-PLIER  
..... 91.50 EACH  
3 OR MORE  
..... 86.80 EACH

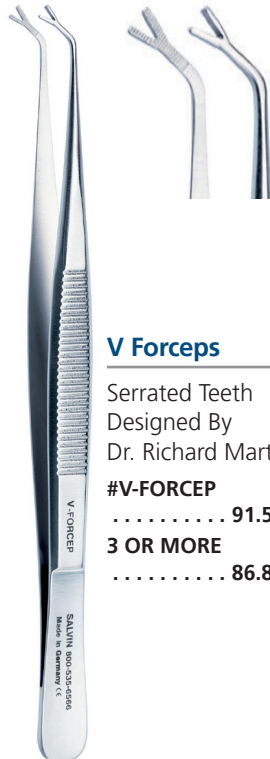

**V Forceps**

Serrated Teeth Designed By Dr. Richard Martin  
#V-FORCEP  
..... 91.50 EACH  
3 OR MORE  
..... 86.80 EACH



**MOST POPULAR**

**Suture Pliers**

Delicate Suture Forcep With 1.6mm Ring Tip  
15.8cm  
#SUTURE-PLIER  
..... 148.80 EACH  
3 OR MORE  
..... 141.50 EACH

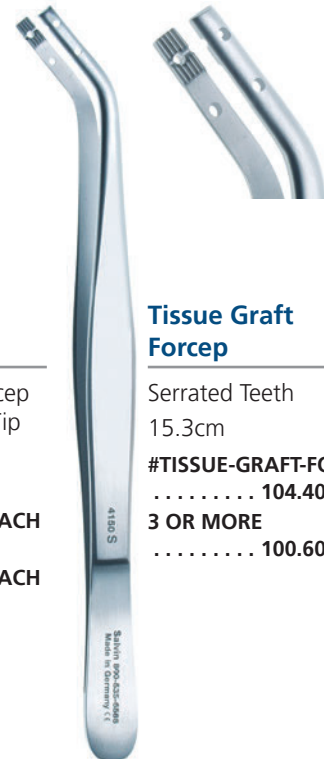

**Tissue Graft Forcep**

Serrated Teeth  
15.3cm  
#TISSUE-GRAFT-FORC  
..... 104.40 EACH  
3 OR MORE  
..... 100.60 EACH

Scalpel Handles

Blade Locks At 90°, 60°, 30°, Straight, 330°, 300°, & 270° Angles

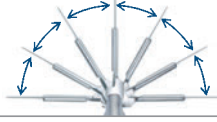

Tighten / Loosen To Lock / Unlock



**MOST POPULAR**

6 Way Adjustable Angled Scalpel Handle

#SCALP-6-WAY-ADJ  
 ..... 247.80 EACH  
 2 OR MORE  
 ..... 234.90 EACH

**MOST POPULAR**

Siegel Round Scalpel Handle

For Precise Control When Rotating Angle Of Incision  
 #SIEGEL ..... 90.10 EACH  
 3 OR MORE ..... 82.90 EACH

Siegel Round Angled Scalpel Handle

For Precise Control When Rotating Angle Of Incision  
 #SIEGEL-ANGLED..... 90.10 EACH  
 3 OR MORE ..... 82.90 EACH

**MOST POPULAR**

#3 Scalpel Handle

#SCALP..... 28.20 EACH  
 3 OR MORE .. 25.70 EACH



Push Lever Forward To Remove Blade

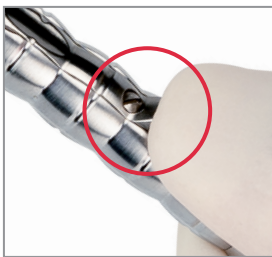

Safety Ejector Scalpel Handle

Safe & Easy Blade Removal  
 #SCALP-SAFETY..... 215.10 EACH



Paquette Blade Holder

Palatal, Gingival & Connective Tissue Grafts  
 Uses Standard Double-Edged Razor Blade  
 15cm Length  
 #SCALP-PAQUETTE  
 ..... 221.60 EACH



Double Bladed Scalpel Handle

1.5mm Blade Separation  
 Uses #12 or #15 Blades  
 #SCALP-DUAL-1.5  
 ..... 183.10 EACH

**Bendable Miniature & Micro Scalpel Blades**

*Uncompromised Sharpness & Cutting Ability*

Blades Are Sterile & Individually Wrapped



*Bendable Blades*

*Use As Straight Blade Or Bend With Needle Holder To Desired Angle (Up To 45°)*

**Bendable Miniature Surgical Blades**



Mini Blade #64  
#BLAD-MINI-64 . . . . . 67.10 BOX OF 12



Mini Blade #67  
#BLAD-MINI-67 . . . . . 67.10 BOX OF 12



Mini Blade #63 - *Full Radius Edge*  
#BLAD-MINI-63 . . . . . 67.10 BOX OF 6

**MOST POPULAR**



Mini Blade #69 - *Full Radius Edge*  
#BLAD-MINI-69 . . . . . 67.10 BOX OF 6

**Bendable Micro-Miniature Surgical Blades**

**MOST POPULAR**



Micro Blade #64  
#BLAD-MICRO-64 . . . . . 51.80 BOX OF 6

**MOST POPULAR**



Nordland Micro Blade #6900 - *Full Radius Edge*  
#BLAD-NORDLAND-69 . . . . . 99.90 BOX OF 6

*Blades Shown Actual Size*



**Blade Handle For Miniature & Micro Surgical Blades**

#BLAD-HANDLE . . . . . 74.30 EACH



**Miniature & Micro Surgical Blade Handle**

#TVA-BLAD-HANDLE . . . . . 138.90 EACH

**Standard Scalpel Blades**



**Carbon Steel Blades For Regular Scalpel Handles**

Extremely Sharp, Sterile & Individually Wrapped

	1 Box	2 Or More Boxes
#BLAD 12	BOX OF 100 . . . . . 65.30	BOX . . . . . 61.20
#BLAD 12B	BOX OF 100 . . . . . 65.30	BOX . . . . . 61.20
#BLAD 15	BOX OF 100 . . . . . 65.30	BOX . . . . . 61.20
#BLAD 15C	BOX OF 100 . . . . . 94.50	BOX . . . . . 89.40

*Blades May Be Assorted For "2 Or More Box" Pricing*



### Super Sharp Disposable Tissue Punches

#### Sterile Disposable Tissue Punches

- Razor Sharp Cutting Edge
- Individually Packaged Sterile - Box Of 50
- Can Be Used In Single Tooth Sites

**MOST POPULAR**

**MOST POPULAR**

● 3.5mm

● 4.0mm

● 5.0mm

● 6.0mm

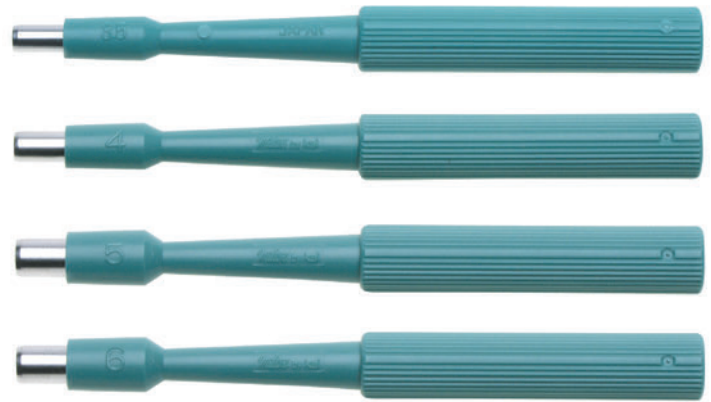

3.5MM PUNCHES-BOX OF 50  
 4.0MM PUNCHES-BOX OF 50  
 5.0MM PUNCHES-BOX OF 50  
 6.0MM PUNCHES-BOX OF 50

	1 Box	2 Boxes
#PUNCH-3.5	170.80 BOX	159.90 BOX
#PUNCH-4.0	170.80 BOX	159.90 BOX
#PUNCH-5.0	170.80 BOX	159.90 BOX
#PUNCH-6.0	170.80 BOX	159.90 BOX

#### Short Sterile Disposable Tissue Punches

- Razor Sharp Cutting Edge
- Individually Packaged Sterile - Box Of 50
- Designed For Edentulous Areas - Not For Single Tooth Sites



3.5MM SHORT PUNCHES-BOX OF 50  
 4.0MM SHORT PUNCHES-BOX OF 50  
 5.0MM SHORT PUNCHES-BOX OF 50  
 6.0MM SHORT PUNCHES-BOX OF 50

	1 Box	2 Boxes
#PUNCH-SHORT-3.5	170.80 BOX	159.90 BOX
#PUNCH-SHORT-4.0	170.80 BOX	159.90 BOX
#PUNCH-SHORT-5.0	170.80 BOX	159.90 BOX
#PUNCH-SHORT-6.0	170.80 BOX	159.90 BOX

*Disposable Punches Are One Size Per Box  
 Boxes May Be Combined For "2 or More Box" Pricing*

### Stainless Steel Multi-Use Rotary Tissue Punches

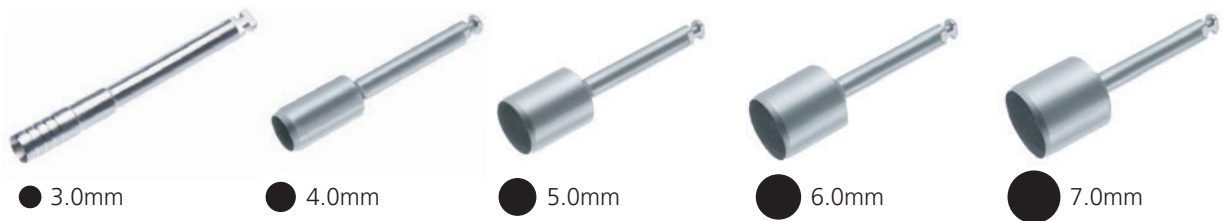

● 3.0mm

● 4.0mm

● 5.0mm

● 6.0mm

● 7.0mm

3.0MM ROTARY PUNCH  
 4.0MM ROTARY PUNCH  
 5.0MM ROTARY PUNCH  
 6.0MM ROTARY PUNCH  
 7.0MM ROTARY PUNCH

#PUNCH-3-ROTARY	126.60 EACH
#PUNCH-4-ROTARY	126.60 EACH
#PUNCH-5-ROTARY	126.60 EACH
#PUNCH-6-ROTARY	126.60 EACH
#PUNCH-7-ROTARY	126.60 EACH



Use With Latch Type Implant Handpiece

**SPECIAL**

#### Rotary Tissue Punch Kit



**MOST POPULAR**

Set Of 5 Punches With Autoclavable Block  
 #PUNCH-ROTARY-KIT  
**565.00 SET OF 5 W/BLOCK**

**Stainless Steel Tissue Punches**

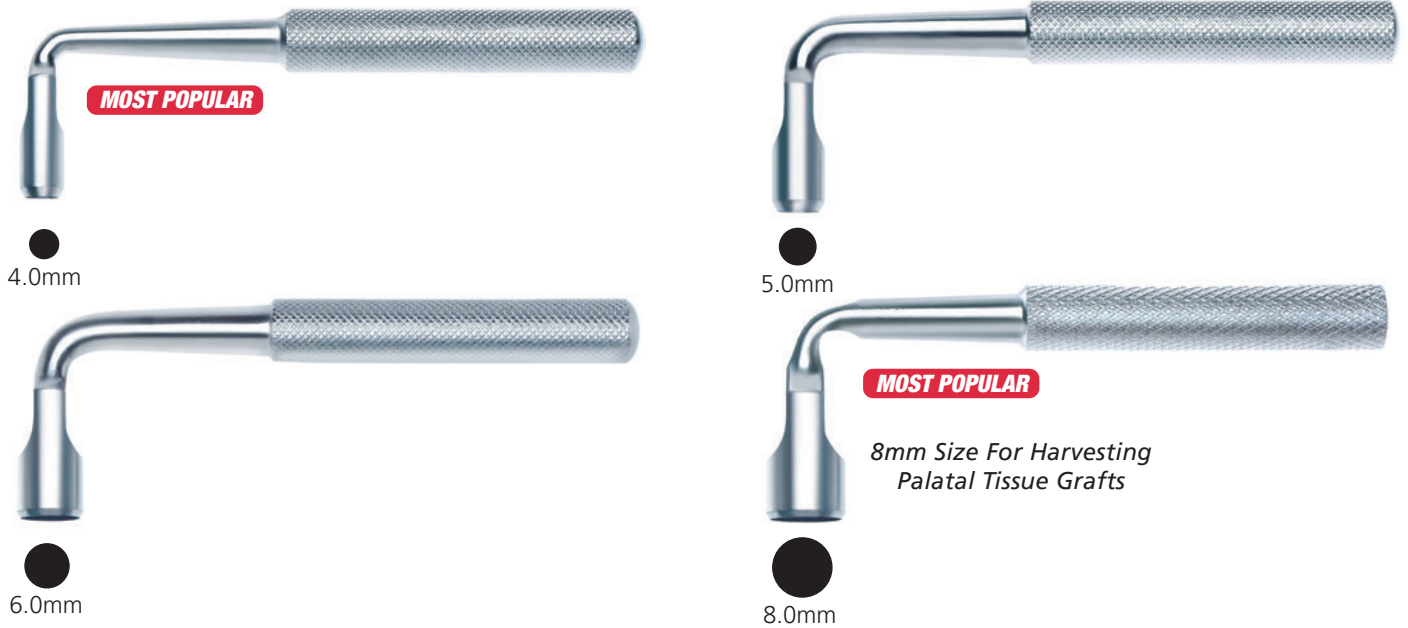

**Stainless Steel Tissue Punches - Offset**

	Individually	3 or More
4.0MM OFFSET PUNCH	#PUNCH-SS-4-RA . . . . . 103.50 EACH . . .	.98.40 EACH
5.0MM OFFSET PUNCH	#PUNCH-SS-5-RA . . . . . 103.50 EACH . . .	.98.40 EACH
6.0MM OFFSET PUNCH	#PUNCH-SS-6-RA . . . . . 103.50 EACH . . .	.98.40 EACH
8.0MM OFFSET PUNCH	#PUNCH-SS-8-RA . . . . . 103.50 EACH . . .	.98.40 EACH

*Stainless Steel Punches May Be Assorted For "3 or More" Pricing*

**Tissue Flap Punch**



**Garvar Tissue Flap Punch  
Implant Exposing Forcep**

Designed By Dr. Lanny Garvar

- Use To Contour Tissue Around Implant
- 5mm Diameter Ring

#FLAP-PUNCH . . . . . 292.20 EACH

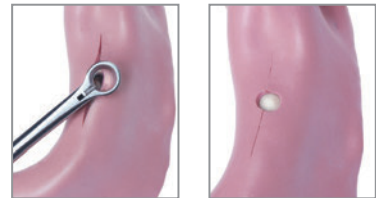

**Tissue Punch Forcep**



**Tissue Punch Forcep**

To Remove Tissue After Using Punch

#TISSUE-PUNCH-FORC. . . . . 78.10 EACH  
3 OR MORE . . . . . 73.80 EACH



Start With Your Choice Of Tissue Punch → Remove Tissue With Forcep

SALVIN  
**Rapid Roll®**



**MOST POPULAR**

- Easy To Use Cover Ring Slides Over Long Hoses In Seconds
- Individually Packaged - 65" (165cm) Long

#RAPID-ROLL

BOX OF 25 ..... 113.80 BOX  
2 OR MORE BOXES ..... 105.50 BOX



**Latexfree**



**Disposable Sterile Suction Tubing & Yankauer Suction Tips**



**Latexfree**

**MOST POPULAR**

**6' Sterile Suction Tubing**

- 6' (182.9cm) x 1/4" (0.6cm) Inside Diameter
- Individually Packaged

#SUCTION-TUBE-6

BOX OF 50 ..... 180.90 BOX (2.99 EACH)  
2 OR MORE ..... 171.30 BOX (2.81 EACH)



**Disposable Sterile Yankauer Tips**

- Blue Translucent Plastic Minimizes Patient Visibility Of Fluids
- Flange Tip & Vent

#YANKAUER-DISPOSABLE

BOX OF 50 ..... 132.90 BOX  
2 OR MORE ..... 123.60 BOX

**10' Sterile Suction Tubing**

- 10' (304.8cm) x 1/4" (0.6cm) Inside Diameter
- Individually Packaged

#SUCTION-TUBE-10

BOX OF 50 ..... 192.90 BOX (3.19 EACH)  
2 OR MORE ..... 182.30 BOX (2.99 EACH)



**MOST POPULAR**

**Surgical Tubing To Dental Suction Adapter**

Adapts Surgical Tubing To Standard Perio & General Dentistry High Volume Suction

#TUBETIP ..... 29.00 EACH

### Autoclavable Tubing Adapter

Use Autoclavable Surgical Tubing With Your Regular High Volume Suction



Latexfree

Connects To Your  
Regular Dental Suction



**MOST POPULAR**

#### Autoclavable Tubing Adapter

- Autoclavable Hundreds Of Times
- Non-Crimping "U" Adapter Connects To Regular Dental Suction
- 5'(152.4cm) x 1/4"(0.6cm) ID Silicone Surgical Tubing
- Fits All Aspirator Tips

#TUBING ADAPT . . . . . 48.40 EACH  
2 OR MORE . . . . . 46.90 EACH

● 1/4"(0.6cm) Inside Diameter

### Autoclavable Silicone Surgical Suction Tubing

Remains Flexible...Autoclavable Hundreds Of Times



Latexfree

**MOST POPULAR**

#### Silicone Tubing By The Foot

1/4"(0.6cm) Internal Diameter  
#TUBING. . . . . 4.55 FOOT  
50 FT OR MORE . . . . . 4.05 FOOT



#### End To End Connector

#TUBE CONNECT. . . . 16.50 EACH  
3 OR MORE . . . . . 15.20 EACH

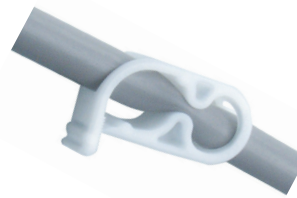

**MOST POPULAR**

#### Autoclavable Cut Off Clamp

#CUT. . . . . 10.60 EACH  
3 OR MORE . . . . . 9.30 EACH



Connects High  
Volume Surgical  
Aspirators To  
Surgical Tubing



#### High Volume Adapter

Connects High Volume Surgical  
Aspirators To Surgical Tubing  
#HVE NECK ADAP . . . . 47.50 EACH

### Autoclavable Suction Cut Off Valves

- Smooth On/Off Lever Action
- Easy To Remove & Clean



**MOST POPULAR**

#### Flip Saliva Ejector Valve

- Fits 7/32" Saliva Ejector Tubing
- Autoclavable Silicone Head
- Includes Cleaning Brush

#FLIP-SE . . . . . 68.00 EACH



#### Flip-D Cut Off Valve

- Fits Standard 1/2" Tubing
- Includes Cleaning Brush

#FLIP-D . . . . . 68.00 EACH



#### Flip-A Cut Off Valve

- Fits Standard 1/2" Tubing
- Includes Cleaning Brush

#FLIP-A . . . . . 68.00 EACH



Surgical Aspirators

<p>1.5mm</p>	<p><b>1.5mm Surgical Aspirator</b> #15P1A . . . . . 40.30 EACH</p>
<p>2.5mm</p>	<p><b>2.5mm Surgical Aspirator</b> #15P2A . . . . . 40.30 EACH</p>
<p>3.0mm</p>	<p><b>MOST POPULAR</b> <b>3mm Surgical Aspirator</b> #15P3A . . . . . 40.30 EACH</p>
<p>4.0mm</p>	<p><b>MOST POPULAR</b> <b>4mm Surgical Aspirator</b> #16RSA . . . . . 40.30 EACH <i>Recommended Cleaning Brushes: Medium &amp; Small</i></p>
<p>2.0mm</p>	<p><b>2mm Modified Frazier</b> #FR2A . . . . . 52.70 EACH</p>
<p>3.0mm</p>	<p><b>3mm Modified Frazier</b> #FR3A . . . . . 52.70 EACH</p>
<p>4.0mm</p>	<p><b>MOST POPULAR</b> <b>4mm Modified Frazier</b> #FR4A . . . . . 52.70 EACH <i>Recommended Cleaning Brushes: Small &amp; Medium</i></p>

Control Suction By  
Covering Relief Hole

**Aspirators On This Page Fit  
Surgical Tubing  
Or  
Standard High Volume Suction**

Autoclavable Cleaning Brushes

		<p>#BRUSH-MEDIUM . . . . . 39.00 DOZEN</p>
		<p>#BRUSH-SMALL . . . . . 39.00 DOZEN <b>MOST POPULAR</b></p>
		<p>#BRUSH-X-SMALL . . . . . 39.00 DOZEN</p>



### Silicone Tip Aspirator Kit

- Autoclavable Silicone Tips Prevent Metal Contact With Implant
- Tips Are Easily Modified With Scissors Or Knife



**MOST POPULAR**

#### Silicone Tip Aspirator Kit

Stainless Steel Aspirator &  
1 Trimmable Silicone Tip

#46YST . . . . . 40.30 EACH

#### Silicone Tips

Set Of 3 Trimmable Silicone Tips

#YST . . . . . 32.00 SET OF 3

*Recommended Cleaning Brushes:  
Medium*

### No-Clog Surgical Aspirators

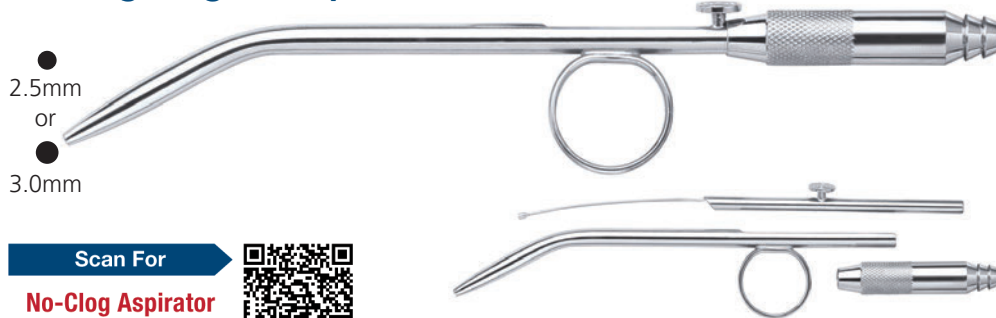

2.5mm  
or  
3.0mm

Scan For  
**No-Clog Aspirator  
Technique Guide**



#### No-Clog Aspirator

Built-In Clog Ejector  
Sliding Button Forward Ejects  
The Clog

**(2.5MM TIP)**

#B2 NO CLOG . . . . . 134.00 EACH

**MOST POPULAR**

**(3.0MM TIP)**

#B3 NO CLOG . . . . . 134.00 EACH

*Recommended Cleaning Brushes:  
Small & Medium*

### Micro Aspirators For Endo/Root Tip Suctioning



1.0mm

2.0mm

#### 1mm Micro/Endo Aspirator

Bendable Tubing  
Includes Cleaning Stylet

#02BA. . . . . 95.00 EACH

**MOST POPULAR**

#### 2mm Micro/Endo Aspirator

Bendable Tubing  
Includes Cleaning Stylet

#03BA. . . . . 95.00 EACH

*Recommended Cleaning Brushes:  
X-Small*

### Micro/Endo Suction Handle



**MOST POPULAR**

#### Micro/Endo Suction Handle

Connects To Saliva Ejector Suction  
Includes 10 Non-Sterile  
Blunt Catheters

#SUCT-LL . . . . . 52.70 EACH

#### Sterile Luer Lock Catheters

#BLUNT-CATH-18G-2.5CM  
. . . . . 121.90 BOX OF 100

#### Non-Sterile Luer Lock Catheters

#SUCT-LL-TIP-14GA . . . . . 40.20 BOX OF 100

#SUCT-LL-TIP-18GA . . . . . 40.20 BOX OF 100

#SUCT-LL-TIP-20GA . . . . . 40.20 BOX OF 100



**External Irrigation Wand Systems**

- Available With Or Without Suction
- Uses Pump Up Pressure Cuff
- Includes Autoclavable Silicone Irrigation Tubing & IV Bag Striker Insert

Scan For  
**Suction Irrigator  
Technique Guide**



**MOST POPULAR**

**Wand Irrigator - Without Suction**

Complete Kit  
#IRR-SET . . . . . 205.00 SET



**Wand Irrigator - With Suction**

Complete Kit Including Built In Suction Aspirator  
Order Suction Tubing Separately  
#SUCT-IRR-SET . . . . . 308.00 SET



**Replacement Irrigation Tubing**

#SILICONE-IRR-TUBING  
. . . . . 21.10 FOR 7FT



Wand Irrigator With Suction Connects  
To 1/4" Disposable Suction Tubing Or  
Salvin Autoclavable Suction Tubing  
On Pages 145

**Stainless Steel Bowls**



**Solution Bowl**

- Heavy Duty Stainless Steel (20 oz)
- 5" x 2 3/8" (12.7 x 6.1cm)

#SOLN BOWL 5 . . . . . 32.70 EACH  
2 OR MORE . . . . . 30.30 EACH



**MOST POPULAR**

**Prep Cup**

- Heavy Duty Stainless Steel (6 oz)
- 3 1/2" x 2" (8.9 x 5.1cm)

#PREP CUP . . . . . 22.90 EACH  
2 OR MORE . . . . . 20.80 EACH

**Sterile Water**



**Sterile Water-Bottles**

- Bottles For Pouring
- 1000 mL

#H2O 1000 BOT  
CASE OF 16 ..... 108.90 CASE

*Please Order Carefully. No Returns On Opened Cases.*

**Sterile Saline**



**Sterile Saline-250 mL**

- 0.9% Sodium Chloride Bags
- 250 mL

#NACL 250 BAG  
CASE OF 36 ..... 243.90 CASE



**MOST POPULAR**

**Sterile Saline-500 mL**

- 0.9% Sodium Chloride Bags
- 500 mL

#NACL 500 BAG  
CASE OF 24 ..... 174.90 CASE



**Sterile Saline-1000 mL**

- 0.9% Sodium Chloride Bags
- 1000 mL

#NACL 1000 BAG  
CASE OF 12 ..... 84.90 CASE



**Sterile Saline-Bottles**

- 0.9% Sodium Chloride
- Bottles For Pouring
- 1000 mL

#NACL-1000-BOTTLE  
CASE OF 16 ..... 110.90 CASE



**Sterile Saline-10 mL Syringes**

- Convenient For Mixing Graft Materials
- 0.9% Sodium Chloride
- 10 mL

#NACL-10-SYRINGE  
CASE OF 30 ..... 55.60 CASE

*Please Order Carefully. No Returns On Opened Cases.*

**Sterile D5W (5% Dextrose Solution)**



**Sterile D5W**

5% Dextrose Bags 500 mL

#D5W 500  
CASE OF 24 ..... 156.90 CASE

*Please Order Carefully. No Returns On Opened Cases.*

**Irrigating Syringes & Catheters**



**Sterile Irrigating Syringes**

- 60cc Luer Lock Syringes
- Sterile - Individually Packaged

#SYRINGE-STERILE-60CC  
BOX OF 40 ..... 71.90 BOX  
2 OR MORE BOXES ..... 68.30 BOX



**Sterile Irrigating Catheters**

- Sterile Blunt Catheters
- 18 Ga x 1" (2.54cm)
- Individually Packaged

#BLUNT-CATH-18G-2.5CM  
BOX OF 100 ..... 121.90 BOX  
2 OR MORE BOXES ..... 112.80 BOX



**Monoject #412 Irrigating Syringes**

- 12cc Disposable Syringes
- Curved Tip
- Packaged Non-Sterile

#MONOJECT-412  
BOX OF 50 ..... 57.70 BOX  
2 OR MORE BOXES ..... 53.90 BOX

**Durable Steel Salvin Implant / Surgical Cart**  
*Accommodates Implant Motors, Piezotomes & Vital Sign Monitors*



*All Metal Construction*  
*41.5" Working Height For Optimal Visibility Of Equipment Screens*

**Salvin Implant / Surgical Cart**

- Pull Out Side Extension
- Removable Antimicrobial Plastic Top For Easy Cleaning
- No Slam, Soft Closing Drawers
- Removable Ergonomic Side Handles
- 5" Easy Rolling Wheels With Locks
- Power Strip With Six Outlets Attached For Easy & Neat Wire Management
- Foot Pedal Fits In Bottom Space For Mobility & Storage
- 20.5" Wide x 18.5" Deep x 41.5" Tall (Height Includes Wheels)

**#SURG-CART-STEEL . . . . . 1695.00**



*Spacious Drawers Accommodate Supplies & Wrapped Cassettes*



*Pull Out Extension Supports Instruments or Equipment*

*Surfaces & Instruments Shown Undraped For Clarity*

Over The Patient Tables



**MOST POPULAR**

**“Over The Patient” Surgical Table**

- Putty Color Work Top Is 24” x 39” (61cm x 99cm)
- Height Adjusts From 31” To 46” Tall (78.75cm To 116.85cm)
- Dimension Between Legs Is 34” (86.4cm)

#SURG-TABLE-24X39 . . . . . 1990.00 EACH



**Stainless Steel “Over The Patient” Surgical Table**

- Extra Heavy-Duty Hospital Style Stainless Steel
- Work Top Is 24” x 48” (61cm x 122cm)
- Height Easily Adjusts With Hand Crank From 36” to 56” (91.5cm to 142cm)
- Dimension Between Legs Is 40” (101.6cm)

#SURG-TABLE-STAINLESS . . . . . 3590.00 EACH

Memory Foam Chair Pad For “Long Appointment” Patient Comfort

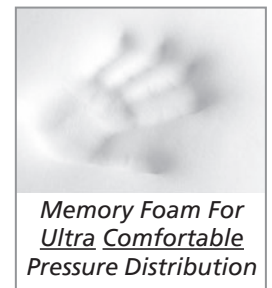

**MOST POPULAR**

- Fits All Dental Chairs - 61” Long x 18” Wide x 3” Thick
- Non-Skid Bottom Won’t Slip Or Move On Your Chair
- Sealed Seams & Fluid Proof Top Cover For Infection Control
- Anti-Microbial Foam & Cover

#CHAIR-PAD-SET . . . . . 744.00 CUSHION & HEADREST  
2 OR MORE . . . . . 692.00 CUSHION & HEADREST



Mayo & IV Stands



**MOST POPULAR**

**Heavy Duty Mayo Stand**

- Tray Size Is 19 1/8" x 12 5/8" (48.6cm x 32cm)
- Adjusts From 33" To 53" (83cm to 135cm)
- Includes Stainless Steel Tray

#MAYO STAND ..... 323.40 EACH



**Center Post Mayo & Implant Motor Stand**

- Tray Size Is 19 1/8" x 12 5/8" (48.6cm x 32cm)
- Adjusts From 29 1/2" To 50" (75cm to 127cm)
- Includes Stainless Steel Tray

#MAYO-STAND-CP..... 331.90 EACH



**Heavy Duty IV Stand**

- Adjusts From 51 1/4" To 94" (130cm to 239cm)
- Chrome Plated Heavy Bar Steel

#IV STAND ..... 173.90 EACH

**Sterile Mayo Stand Cover**

- Individually Packaged
- Fits Regular Mayo Stands
- 24" x 24" (61 x 61cm)

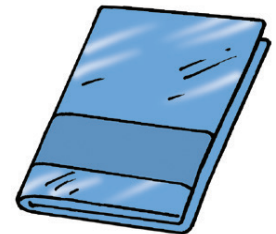

#MAYO-COVER  
 CASE OF 24..... 305.00 CASE  
 2 OR MORE CASES ..... 294.80 CASE

**Latexfree**

**Sterile Surgical Table Cover**

- Individually Packaged
- Fits Surgical Tables
- 53" x 77" (134 x 195cm)

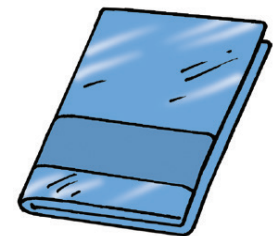

#SURG-TABLE-COVER  
 CASE OF 20..... 106.70 CASE  
 2 OR MORE CASES ..... 99.40 CASE

**Latexfree**



**SALVIN**  
**ENLIGHTEN-PRO3™**  
LED SYSTEM

- Continuously Variable Adjustable Intensity
- 100,000 Hour LED Life
- Dual Lithium Polymer Battery Pack
  - 6.5 Hour Capacity On High
  - 14 Hour Capacity On Medium
  - 50 Hour Capacity On Low
- Spot Size Adjusts To 3.5" At 18" Working Distance
- Total Weight: 11oz (311g)
- Optimized Weight Balance And Comfort
- 2 Year Warranty

**MOST POPULAR**



Includes Batteries & Charger



Includes Anti-Curing Filter



Use With Your Loupes



Includes Carrying Case

**SPECIAL**

**Enlighten-Pro3™ LED Headlamp System**

**Includes:**

- Enlighten-PRO3™ LED Headlamp
- Secure Carrying Case
- Anti-Curing Filter
- 2 Lithium Batteries, Charger & Cable

#HL-PRO3-PKG..... 1995.00

- **Patented Technology**  
*Reduces LED Temperature*
- **No Cables Or Belt Packs**
- **100,000 LUX At 10" (25cm)**
- **15,000 LUX At 18" (46cm)**  
*- Preferred Working Distance For Most Doctors*  
*(Important To Measure At Your Working Length*  
*As Luminance Decreases With Distance)*

**Enlighten-Pro3™ Accessories**



**Extra Enlighten-Pro3™ Lithium Batteries - Set Of 2**

#HL-PRO3-BAT (SET OF 2)..... 300.00



**Optional Enlighten-Pro3™ Four-Bay Charging Station**

- Charge Up To Four Batteries At Once
- Charge Status Indicators For Each Battery
- Batteries Not Included

#HL-PRO-DOC ..... 550.00

Implant Model Package Specials

**SPECIAL**

Bar Overdenture Model + Crown & Bridge Model

**MOST POPULAR**



MOD D4



MOD-C7

**Implant Model Special #1**

Regular Price For Package Is 876.00 - **Save 125.00**

#MOD-SPECIAL-D4&C7  
**751.00 FOR BOTH MODELS**

**SPECIAL**

Locator™ Model + Crown & Bridge Model

**MOST POPULAR**



MOD LOC-2



MOD-C7

**Implant Model Special #2**

Regular Price For Package Is 795.00 - **Save 120.00**

#MOD-SPECIAL-LOC2&C7  
**675.00 FOR BOTH MODELS**

**SPECIAL**

Bar Overdenture + Locator™ + Crown & Bridge + "On 4" Models

**MOST POPULAR**



MOD D4



MOD LOC-2



MOD-C7



MOD-COMplete-4

**Implant Model Special #3**

Regular Price For Package Is 1655.00 - **Save 244.00**

#MOD-SPECIAL-SETOF4  
**1411.00 FOR ALL 4 MODELS**

**SPECIAL**

Set Of Both Mandible & Maxilla Bone Loss Models

**MOST POPULAR**



MOD MM



MOD MMM

**Set Of Both Mandible & Maxilla Bone Loss Models**

#MOD-SET  
**253.00 FOR BOTH MODELS**

Crown & Bridge Implant Models



3 Unit Bridge On 2 Implants  
Single Crown On 1 Implant  
#MOD C2 ..... 324.00



**MOST POPULAR**  
3 Unit Bridge On 3 Implants  
Single Crown On 1 Implant  
3 Unit Natural Tooth Bridge  
#MOD-C7 ..... 451.00



Single Posterior Implant Crown  
Single Anterior Implant Crown  
3 Unit Natural Tooth Bridge  
#MOD-C8 ..... 451.00



6 Implant High Water Bridge  
#MOD HWB-6 ..... 351.00



6 Implant Full Arch Cemented  
#MOD C4 ..... 526.00



**MOST POPULAR**  
Complete "On 4" Restoration  
#MOD-COMplete-4 ..... 435.00



Complete "On 6" Restoration  
#MOD-COMplete-6 ..... 451.00



**Most of Our Models Can Be Customized  
With Your Practice Or Study Club Name  
Please Call For Quantity Pricing**

More Models On Next Pages →



Hader Bar Implant Models



**MOST POPULAR**

4 Implant Hader Clip Bar  
Lower Overdenture

#MOD D4..... 425.00

5 Implant Hader Clip Bar  
Lower Overdenture

#MOD-D5..... 445.00

6 Implant Hader Clip Bar  
Upper Overdenture

#MOD-D6-UPPER..... 475.00

"O" Ring Abutment Implant Models



2 Implant "O" Ring  
Lower Overdenture

#MOD D2-O..... 279.00



**MOST POPULAR**

4 Implant "O" Ring  
Lower Overdenture

#MOD D4-O..... 309.00



*Most of Our Models Can Be Customized  
With Your Practice Or Study Club Name  
Please Call For Quantity Pricing*



Locator™ Abutment Implant Models



**MOST POPULAR**

4 Implant Locator™ Abutment  
Upper Overdenture  
#MOD-LOC-4-UPPER ..... 434.00



4 Implant Locator™ Abutment  
Lower Overdenture  
#MOD-LOC-4 ..... 434.00



3 Implant Locator™ Abutment  
Lower Overdenture  
#MOD-LOC-3 ..... 405.00



**MOST POPULAR**

2 Implant Locator™ Abutment  
Lower Overdenture  
#MOD-LOC-2 ..... 344.00

Locator™ Is A Trademark of Zest Anchors, Inc.



*Most of Our Models Can Be Customized  
With Your Practice Or Study Club Name  
Please Call For Quantity Pricing*

Bone Loss Models



**MOST POPULAR**

**Mandible Bone Loss Model Set**

- 4 Mandibles Show Progressive Bone Loss
- Shows Benefits Of Augmentation & Consequences Of No Treatment

#MOD MM . . . . . 137.00 EACH

**Maxilla Bone Loss Model Set**

- 4 Maxillas Show Progressive Bone Loss
- Shows Benefits Of Augmentation & Consequences Of No Treatment

#MOD MMM . . . . . 165.00 EACH

**Atrophied Ridge Mandible**

Atrophied Ridge Mandible Shows Vertical & Horizontal Defects

#MAND-RIDGE-ATROPH . . . . . 58.00 EACH

**SPECIAL**

**MOST POPULAR**

Set Of Both Mandible & Maxilla Bone Loss Models

#MOD-SET . . . . . 253.00 FOR BOTH



Anatomical Skull Models



**MOST POPULAR**

**Anatomically Correct Skull Model**

Removable Mandible

#SKULL-CLASSIC . . . . . 202.00 EACH

2 OR MORE . . . . . 183.40 EACH



Shows Roots & Impacted 3rd Molar

**Extractable Teeth Skull Model**

Removable Bone Flap Shows Roots, Nerve Canal & Impacted Wisdom Tooth

#SKULL-EXTRACTIONS . . . . . 320.40 EACH

2 OR MORE . . . . . 297.90 EACH



**Skull Model With Opened Lower Jaw**

Buccal Plate Removed Shows Roots, Vessels & Nerves

#SKULL-OPEN-JAW . . . . . 382.30 EACH

2 OR MORE . . . . . 355.20 EACH

Teaching Models For Hands-On Courses



**MOST POPULAR**

**Suturable Implant Drilling Mandibles**

Similar In Density To Bone With Suturable Rubber Surface

#MAND SUTURABLE . . . . .69.40 EACH  
12 OR MORE . . . . .66.70 EACH  
24 OR MORE . . . . .63.90 EACH



**MOST POPULAR**

**Implant Drilling Mandibles**

Similar In Density To Bone

#MAND TEACH . . . . .24.00 EACH  
12 OR MORE . . . . .22.20 EACH  
50 OR MORE . . . . .20.30 EACH



**Drillable Sinus Lift Teaching Model**

Similar In Density To Bone With Rubber Sinus Membrane

#SINUS TEACH. . . . .122.00 EACH  
12 OR MORE . . . . .113.30 EACH

*Call For Study Club & Implant Course Volume Pricing*

Case Presentation

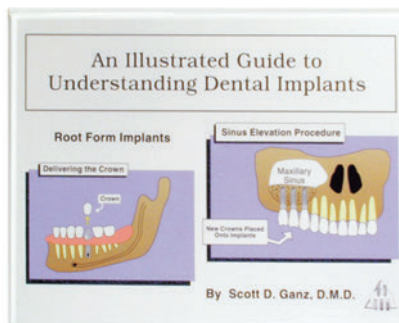

**Illustrated Implant Guide  
By Dr. Scott Ganz**

- Full Color Illustrations & "Patient Friendly" Text
- Ideal For The Specialist Or Referring Doctor
- Step-By-Step Guide To The Implant Procedure

**ENGLISH VERSION**

#ILLUS GUIDE. . . . . 73.40 EACH  
3 OR MORE . . . . . 67.60 EACH

**SPANISH VERSION**

#ILLUS GUIDE-S . . . . . 73.40 EACH  
3 OR MORE . . . . . 67.60 EACH

Spotter Smart Implant Detector



Accurately Locates Covered Dental Implants

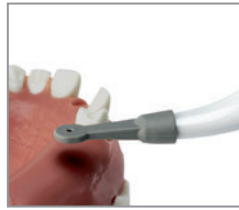

- Easily Finds Buried Titanium Implants
- Saves Time And Minimizes Recovery Period



Spotter Smart Implant Detector

Includes One Sterilizable Detachable Sensor (Recommended For 10 Uses)

#SPOTTER ..... 755.00



Spotter Sensor Replacements

Package of 5

#SPOTTER-SENSORS-5 ..... 140.00 PACKAGE OF 5

Surgical Rulers & Markers



**MOST POPULAR**

Surgical Ruler

Stainless Steel 6" (15.25cm) Surgical Ruler

#SURGRULER  
 INDIVIDUALLY ..... 15.10 EACH  
 2 OR MORE ..... 13.20 EACH



Sterile Marking Pens

Box of 10 Individually Packaged Markers

#TISSUE-MARK  
 BOX OF 10 ..... 52.90 BOX  
 2 OR MORE BOXES ..... 49.40 BOX

X-Ray Distortion Markers



X-Ray Distortion Markers

- Precise 5mm Stainless Balls Calibrate For Distortion On Periapical & Panoramic Films
- Incorporate Markers Into A Plastic Stent When Taking Radiograph, Then Use 5mm Diameter As A Reference When Taking Measurements On Your Film

#RADIO MARK ..... 32.50 BAG OF 50

Diagnostic Probes



**Nabers-1N  
Furcation Probe**

#PROBE-NABERS-1N  
.....44.30 EACH  
3 OR MORE  
.....41.80 EACH



**Titanium Tipped**



Depth Marked  
At 1-15mm

**Titanium  
UNC Probe**

#PROBE-UNC-TITANIUM  
.....53.90 EACH  
3 OR MORE  
.....50.40 EACH



**Titanium Tipped**



Depth Marked  
3, 6, 9 & 12mm

**Titanium  
CP12 Probe**

#PROBE-CP12-TITANIUM  
.....53.90 EACH  
3 OR MORE  
.....50.40 EACH



**MOST POPULAR**

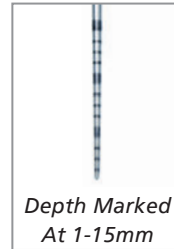

Depth Marked  
At 1-15mm

**Stainless Steel  
UNC Probe**

#PROBE-UNC  
.....36.40 EACH  
3 OR MORE  
.....33.10 EACH

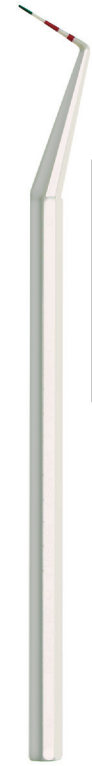

Color Coded At  
3, 6, 9 & 12mm

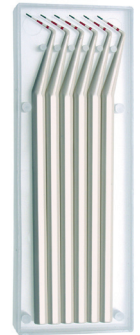

**PerioWise Plastic  
Perio Probes**

- Set Of 6 Perio Probes
- Autoclavable Plastic  
Will Not Scratch Implants

#PERIO-PROBE-6  
.....110.90 SET OF 6  
2 OR MORE SETS  
.....105.10 SET OF 6

Operative Mouth Mirrors & Handles



**MOST POPULAR**

**Mirror Handle  
Cone Socket  
Lightweight**

#MIRR-HNDL  
.....20.30 EACH  
3 OR MORE  
.....18.10 EACH



**SALVIN  
Ergonomic  
Handle**

**Mirror Handle  
Cone Socket  
Lightweight  
Anatomical**

#MIRR-HNDL-A  
.....42.30 EACH  
3 OR MORE  
.....39.10 EACH



**#4 Cone Socket  
Front Surface Mirror**

Rhodium-Coated To  
Reduce Ghost Imaging

#MIRR-4-CS  
.....52.20 BOX OF 12  
5 OR MORE BOXES  
.....48.70 BOX OF 12



**#5 Cone Socket  
Front Surface Mirror**

Rhodium-Coated To  
Reduce Ghost Imaging

#MIRR-5-CS  
.....52.20 BOX OF 12  
5 OR MORE BOXES  
.....48.70 BOX OF 12



Calipers & Gauges

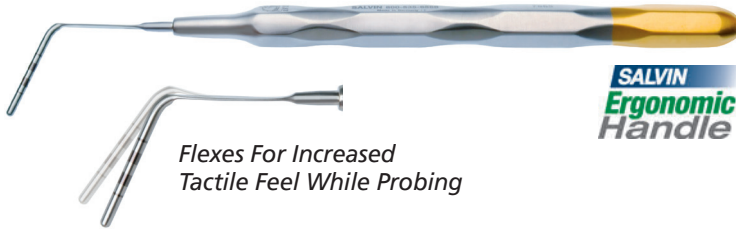

*Flexes For Increased Tactile Feel While Probing*

**SALVIN**  
*Ergonomic Handle*

**Flexible Tip Implant Depth Gauge**

Marked At 6, 8, 10, 12, 14 & 16mm

#DEPTH-FLEX . . . . . 110.90 EACH

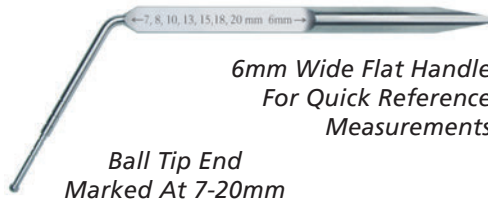

*6mm Wide Flat Handle For Quick Reference Measurements*

*Ball Tip End Marked At 7-20mm*

**MOST POPULAR**

**"Ball Tip" Implant Depth Gauge - Titanium**

- Ball Tip Probe Marked At 7mm To 20mm
- Flat End Of Handle Is 6mm Wide For Reference Measurements

#DEPTH-BALL-TIP . . . . . 97.90 EACH

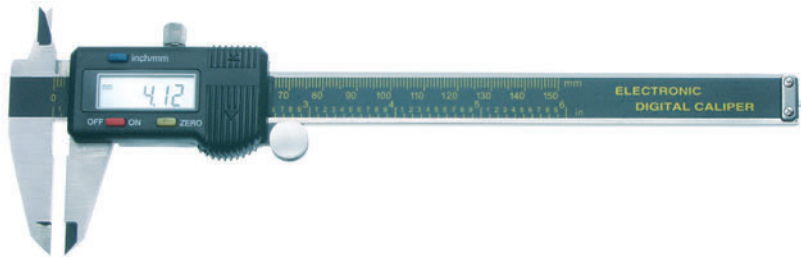

**Electronic Digital Caliper**

- 0-150mm Range
- For Extra-Oral Use Only

#CALIPER-DIGITAL . . . . . 99.90 EACH

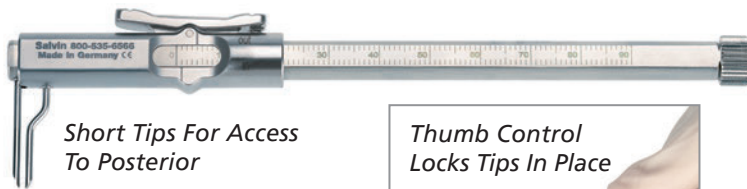

*Short Tips For Access To Posterior*

*Thumb Control Locks Tips In Place*



**MOST POPULAR**

**Sliding Caliper**

- Facilitates Positioning of Implants
- Measures Both Inside & Outside Dimensions
- Sliding Depth Measurement Probe
- 0-90mm Range

#CALIPER-SLIDING . . . . . 298.30 EACH

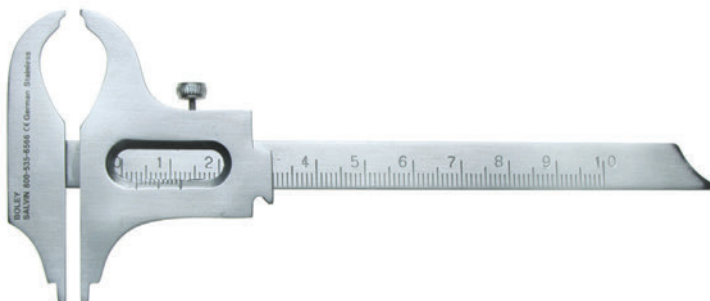

**Boley Gauge Caliper**

0-100mm Range

#BOLEY . . . . . 123.30 EACH

Calipers



**MOST POPULAR**

**Ridge Mapping Caliper**

- For Mapping Bone Width
- Measures 0-25mm Range

#RIDGE-CALIPER . . . . .370.80 EACH



**MOST POPULAR**

**Castroviejo Caliper Short**

- Measures 0-40mm Range
- 9cm Long

#CASTRO-CAL . . . . .334.60 EACH



**Castroviejo Caliper Short - 30° Angled**

- Measures 0-40mm Range
- 9cm Long

#CASTRO-CAL-ANGLED-S . . . . . 334.60 EACH



**Socket Wall Caliper**

- Measures Flap & Socket Wall Thickness
- Measures 0-10mm Range

#CALIPER-SOCKET . . . . .56.10 EACH



**Castroviejo Caliper Long**

- Measures 0-40mm Range
- 17cm Long

#CASTRO-CAL-LONG . . . . .432.80 EACH



**Castroviejo Caliper Long - 30° Angled**

- Measures 0-40mm Range
- 17cm Long

#CASTRO-CAL-ANGLED . . . . .432.80 EACH

### Salvin Implant Drill Guide Set

- *Helps Provide Proper Spacing, Angulation & Parallelism*
- *Autoclavable*

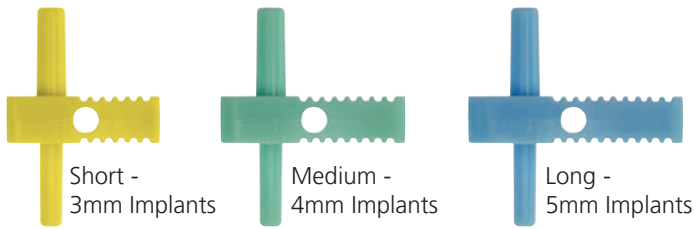

**Regular Drill Guide Set Includes:**



- Set Of 3 Color Coded Drill Guides & Autoclavable Cassette

#IMPL-GUIDE-SETOF3 . . . . . 205.00 SET OF 3 WITH CASSETTE  
 US Patent #6869283B2



Designed By  
 Dr. Harold Sussman



**"Regular Implant" Guide Protocol**

1. Select Color Coded Guide Based On Implant Size. Position Guide Against Adjacent Tooth At A Right Angle To The Jaw
2. Use Perio Probe To Locate Crest Of Ridge, Then Drill Pilot Hole With 2.0mm Drill Parallel To The Guide Pin
3. Place Guide Pin Into Osteotomy & Align Guide Over Ridge
4. Drill Second Pilot Hole Through Metal Ring, Use Paralleling Pin To Confirm Parallel Alignment With Guide Pin

### Salvin Paralleling Guide



**MOST POPULAR**

**Easy Alignment Of Implants In Edentulous Mandibles**

- 1.9mm Diameter Guide Pin
- 7mm Length Guide Pin

#PARALLEL-GUIDE . . . . . 130.10 EACH

### Salvin Paralleling Guide Pins

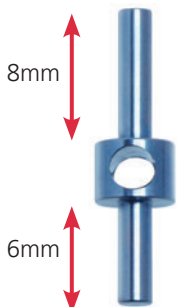

**Paralleling Guide Pins**

- 1.9mm Diameter For 2mm Pilot Drill
- #GUIDE-PIN-PKG-4. . . . 101.90 SET OF 4 PINS
- #GUIDE-PIN-PKG-8. . . . 199.00 SET OF 8 PINS Includes **FREE** Organizing Block

**SPECIAL**

**Salvin Guide Pin**



Set Of 8 Guide Pins With **FREE** Sterilization / Organizing Block

#GUIDE-PIN-PKG-8  
**199.00 KIT W/BLOCK**

Salvin Bendable "Magic" Mirror Handle For Glass Photo Mirrors



**MOST POPULAR**



Handle Securely Holds Glass Photo Mirrors

Easily Bends & Stays In Place For Your Desired Angle

**Bendable Silicone Handle For Glass Photo Mirrors**

Securely Holds Photography Mirror

- #PHOTO-MIRR-MAGIC-HND . . . . . 75.90 EACH
- 2 OR MORE . . . . . 71.60 EACH

**Dual View Photography Mirror**



**Dual View Photo Mirror**

View Buccal, Occlusal & Lingual Surfaces With One Mirror

- #PHOTO-DUALVIEW . . . . . 102.90 EACH

**Photo Contrasters**

*Set Of 2 Contrasters Provide Better Visualization Of Shade & Detail*

**MOST POPULAR**

For Effective Communication With Patient & Laboratory  
Black Background For Better Visualization Of Color, Detail,  
Shade Variations & Translucencies



Without Contraster



With Contraster

Photos: Dr. Ross W. Nash



**Large & Small Contraster Set**

- #CONTRASTER-STR-2 . . . . . 64.90 SET
- 2 OR MORE SETS . . . . . 61.30 SET



*Operative Mirrors On Page 161*

Front Surface Float Glass For Reflected Image With No Distortion

- Mirror Surface On Both Sides
- Sterilization Up To 428°F (220°C)

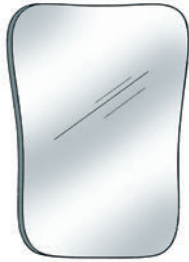
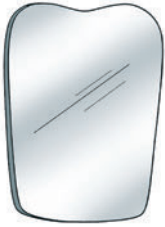

**MOST POPULAR**

**MOST POPULAR**

**Pedo Occlusal**

**Adult Occlusal**

**Adult Occlusal XL**

**Buccal**

**Buccal Narrow**

60mm Wide  
85mm Long  
#PHOTO OCC PED  
INDIVIDUALLY  
..... 78.40 EACH  
2 OR MORE  
..... 74.10 EACH

68mm Wide  
100mm Long  
#PHOTO OCC AD  
INDIVIDUALLY  
..... 78.40 EACH  
2 OR MORE  
..... 74.10 EACH

68mm Wide  
135mm Long  
#PHOTO OCC XL  
INDIVIDUALLY  
..... 99.80 EACH  
2 OR MORE  
..... 93.10 EACH

57mm Wide  
152mm Long  
#PHOTO BUCCAL  
INDIVIDUALLY  
..... 78.40 EACH  
2 OR MORE  
..... 74.10 EACH

41mm Wide  
152mm Long  
#PHOTO-BUCCAL-2  
INDIVIDUALLY  
..... 78.40 EACH  
2 OR MORE  
..... 74.10 EACH

Autoclavable Photo Mirror Cassette

- Silicone Cushions & Locking Crossbar
- Holds Set Of 4 Mirrors:  
Pedo Occlusal, Adult Occlusal, Buccal Narrow, Buccal
- 29 x 18.3 x 3.7cm (11.5" x 7.2" x 1.5" )

#CASS-SS-MIR-4 ..... 168.70 EACH

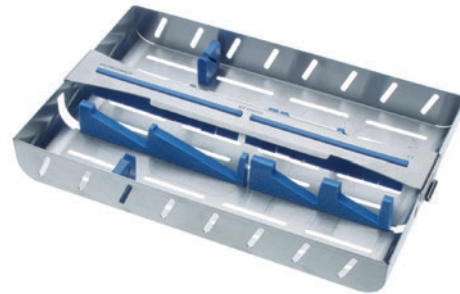

**SPECIAL**

Mirror, Cassette & "Magic Handle" Set

**MOST POPULAR**



*Easily Bends & Stays In Place  
For Your Desired Angle*

**Includes:**

- Pedo Occlusal Mirror
- Adult Occlusal Mirror
- Buccal Mirror
- Buccal Narrow Mirror
- Bendable Silicone "Magic" Mirror Handle
- Stainless Steel Cassette



#PHOTO-KIT-4-MAGIC  
**476.00 COMPLETE SET**



Improv® Temporary Implant Cement For Implants & Natural Teeth



*Eugenol Free &  
Easily Removed From  
Both Hard & Soft Tissue*

**Temporary Implant Cement**

- 90 Seconds Working Time
- Compressive Strength: 57 MPa
- Water Sorption: 1.314mg/cm<sup>3</sup>
- Final Set In 3.5 Minutes
- Film Thickness: <20 Microns
- Shelf-Life: 1.5 Years
- Contains:
  - 2 - 6mL Dual-Barrel Syringes
  - 12 - Mixing Tips
  - 1 - Mixing Pad

#IMPRO-CEMENT. . . . . 119.00 BOX  
3 OR MORE . . . . . 109.90 BOX



**Extra Mixing Tips**

Package Of 30  
#IMPL-CEM-TIPS . . . . . 51.20 BOX

## Safe Relax® Automatic Crown & Bridge Remover

*Adjustable Intensity Handle For Controlled Intensity*



### Safe Relax® Automatic Crown & Bridge Remover

- High Frequency Micro Strokes Provide Up To 20 Movements Per Second
- 5 Intensity Settings For The Comfort Of Controlled Intensity
- Ergonomic Design For Comfortable Grip
- Fits All Electric & Air Driven E-Type Motors
- 1 Year Warranty

### Replacement Tips



Angled Tip For Posterior Teeth

#SAFE-RELAX-TIP-POST . . . . . 28.00 EACH



Straight Tip For Anterior Teeth

#SAFE-RELAX-TIP-ANT . . . . . 28.00 EACH



Flat Hook Tip With Non Slip Grip

#SAFE-RELAX-TIP-FLAT . . . . . 28.00 EACH



Hook Tip For Bridges

#SAFE-RELAX-TIP-BRIDGE . . . . . 28.00 EACH

### SPECIAL

### Safe Relax® Crown & Bridge Remover Kit



**Includes:**

- 4 Tips & Handle
- 3 Wire Tips
- Set Of 3 Replacement Wires

#SAFE-RELAX  
**755.00 COMPLETE KIT**

## Crown Splitters & Spreaders



### Crown Splitter

- Slit The Crown With A Diamond
- Easily Pry Crown Apart
- Reinforced Tip

#### Straight

#CROWN-SPLIT-STR . . . . . 121.40 EACH

**MOST POPULAR**

#### Offset

#CROWN-SPLIT . . . . . 148.90 EACH

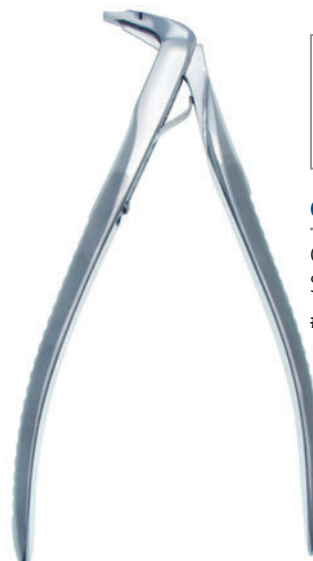

### Crown Spreading Plier

Cut A Slit, Then Squeeze To Spread & Remove The Crown

#CROWN-SPREAD . . . . . 347.60 EACH

Crown Grippers



**Carbide Tipped Crown Gripper**

Slip-Free Gripping Of Crowns,  
Temporaries & Prosthetic Parts

#CROWN GRIP . . . . .238.30 EACH  
2 OR MORE . . . . .229.00 EACH



**Carbide Tipped  
Locking Crown Gripper**

Slip-Free Gripping Of Crowns,  
Temporaries & Prosthetic Parts

#CROWN-GRIP-LOCKING . . . . .238.30 EACH  
2 OR MORE . . . . .229.00 EACH



**MOST POPULAR**

**Rubber Tipped Crown Plier**



Includes 10g Of Silicon Carbide  
Gripping Powder

#CROWN-PLIER-II . . . . .321.60 EACH  
2 OR MORE . . . . .313.20 EACH

**Replacement Silicon Carbide  
Gripping Powder**

10g Container

#CROWN-PLIER-POWDER . . . . .44.30 EACH

**Replacement Crown Plier Tips**



#CROWN-PLIER-TIPS-II . . . . .32.50 SET OF 2  
2 OR MORE SETS . . . . .30.20 SET OF 2

Prosthetic Parts Grippers

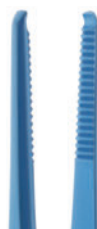

**Titanium Parts Forcep**

For Slip-Free Grasp Of Implant  
Prosthetic Parts

13cm

#TI-PARTS-GRIPPER . . . . .185.70 EACH  
3 OR MORE . . . . .177.00 EACH



**MOST POPULAR**

**TC Gripper Forcep  
Carbide Tipped**

For Slip-Free Grasp Of Implant  
Prosthetic Parts

14.5cm

#TC GRIPPER . . . . .182.70 EACH  
3 OR MORE . . . . .173.60 EACH

**Abutment Holders**



**MOST POPULAR**

**Hebel-Melton Abutment Holder**

Self Tensioning Handle Keeps Parts Secure During Pick Up & Transfer

#HEBEL-MELTON-TI . . . . . 155.70 EACH  
3 OR MORE . . . . . 149.40 EACH



**Angled Posterior Abutment Forceps**

Ideal For Placement In Molar Area Stays Closed When Instrument Is At Rest

#ABUT-FORCEP-75 . . . . . 400.00 EACH  
3 OR MORE . . . . . 380.00 EACH

**Anterior Abutment Forceps**

Stabilizes Abutment For Easy Insertion Stays Closed When Instrument Is At Rest

#ABUT-FORCEP-90 . . . . . 400.00 EACH  
3 OR MORE . . . . . 380.00 EACH

**Premier® Autoclavable Graphite Implant Scalers**

**MOST POPULAR**

**Universal Implant Scaler - Columbia 4L/4R**

- Safe For Use Around Implants
- Resharpen With Clean Sharpening Stone
- Autoclavable Up To 140°C

#IMPL-SCALER-UNIV . . . . . 203.70 SET OF 5  
2 OR MORE . . . . . 194.80 SET OF 5

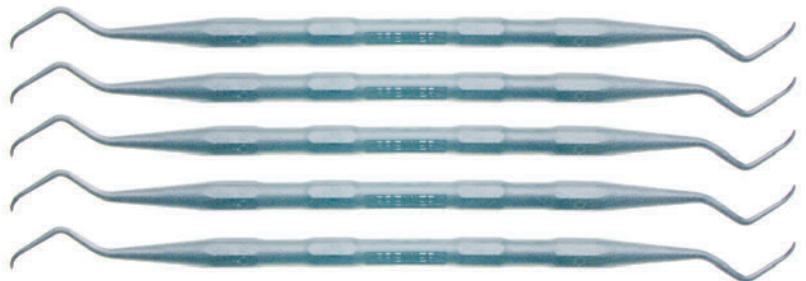

**Implant-Prophy+™ Plastic Hygiene Instruments**

**Plastic Implant Scalers With Sharpening Stone**

- Special Plastic Will Not Scratch Abutment Surface
- Easily Resharpened With Sharpening Stone
- Autoclavable Up To 190°C (375°F)

Set Includes:  
1 Gracey 5/6  
1 Gracey 11/12  
1 Gracey 13/14  
1 Columbia 13/14U  
Sharpening Stone

#PROPHY-INSTRSET . . . . . 139.80 SET OF 4



**Titanium Tip Implant Currettes**

**Langer 1/2 Titanium Curette**

Angled Like A Gracey But  
With Two Cutting Edges

#LANGER-1/2 . . . . . 74.50 EACH

*Titanium Tipped*



**Langer 3/4 Titanium Curette**

Angled Like A Gracey But  
With Two Cutting Edges

#LANGER-3/4 . . . . . 74.50 EACH

*Titanium Tipped*



**Langer 5/6 Titanium Curette**

Angled Like A Gracey But  
With Two Cutting Edges

#LANGER-5/6 . . . . . 74.50 EACH

*Titanium Tipped*



**SPECIAL**

Set Of 3 Langers #TI-LANG-SET-3 . . . . . 178.00 SET OF 3

**H6/H7 Titanium Curette**

#TI-H6/H7 . . . . . 74.50 EACH

*Titanium Tipped*



**204 SD Titanium Curette**

#TI-204SD . . . . . 74.50 EACH

*Titanium Tipped*



**SPECIAL**

H6/H7 & 204 SD #TI-H6-204-SET-2 . . . . . 126.40 SET OF 2

**SPECIAL**

**5 Instrument Titanium Curette Set**

**MOST POPULAR**



**Includes:**

- Titanium Langer 1/2
- Titanium Langer 3/4
- Titanium Langer 5/6
- Titanium H6/H7
- Titanium 204 SD
- Stainless Steel Cassette

#TI-CURETTE-SET-5  
428.00 SET OF 5 W/CASSETTE



SALVIN  
**EASYReach**<sup>®</sup>  
RIGHT ANGLE PROSTHETIC WRENCH

Scan For  
**60** Second  
Product  
Video™



- Excellent Ergonomics With Great Access In Difficult To Reach Areas
- Secures Driver Tip For Patient Safety

- ▶ Right Angle
- ▶ Latch Type

SALVIN  
**Ergonomic  
Handle**



Finger Tip Rotation Easily Tightens Or Loosens Screws

Fits "Latch"  
Driver Tips

**MOST POPULAR**

**EasyReach**<sup>®</sup> Right Angle Prosthetic Wrench

Autoclavable

#EASY-REACH ..... 567.00 EACH



SALVIN<sup>®</sup>  
**AUTO  
TORQ**<sup>®</sup>  
Automatic Electric  
Torque Driver

- Adjustable Torque From 10Ncm To 35Ncm
- Adjustable Speed From 30rpm To 50rpm
- Includes Reverse Function
- Excellent Ergonomics With Great Access In Difficult To Reach Areas
- Secures Driver Tip For Patient Safety

- ▶ Torque Wrench
- ▶ Adjustable Torque
- ▶ Right Angle
- ▶ Latch Type

Now Torques  
Up To 35Ncm



One Button Operation To Achieve Desired Torque



Fits "Latch"  
Driver Tips



**AutoTorq**<sup>®</sup> Automatic Electric Torque Driver

#AUTOTORQ-35 ..... 1500.00 EACH

# SALVIN ACCESS TORQ®

Right Angle Variable Torque Driver



Perfect For All-on-4® Procedures

▶	Torque Wrench
▶	Adjustable Torque
▶	Right Angle
▶	Latch Type



**MOST POPULAR**

## AccessTorq® Right Angle Variable Torque Driver

Autoclavable

Lubricate With Pana-Spray (Page 62) After Each Use & Before Sterilization

#ACCESSTORQ.....999.00 EACH

Rotation Easily Torques Or Loosens Screws



Seven Torque Settings:  
10, 15, 20, 25, 30, 32 & 35 Ncm

Fits "Latch" Driver Tips



All-on-4® is a trademark of NobelBiocare®

## "Latch Type" Prosthetic Driver Tips

	<b>.048" (1.22mm) Tip Hex Driver</b> #HN-LATCH-DRIVER..... 57.40 EACH
	<b>.05" (1.25mm) Tip Hex Driver</b> #HT-LATCH-DRIVER..... 57.40 EACH
	<b>.05" (1.25mm) Tip Hex Driver - Short</b> #HT-LATCH-DRIVER-S..... 57.40 EACH
	<b>.05" (1.25mm) Tip Square Driver</b> #CER-LATCH-DRIVER..... 57.40 EACH
	<b>PROC Tip "Star" Driver</b> #PROC-LATCH-DRIVER..... 79.90 EACH
	<b>PROC Tip "Star" Driver - Short</b> #PROC-LATCH-DRIVER-S..... 79.90 EACH
	<b>LOC Triangle Driver</b> #TRIRA..... 57.40 EACH
	<b>ITI Driver</b> #ITI-LATCH-DRIVER..... 72.60 EACH
	<b>ITI Driver - Short</b> #ITI-LATCH-DRIVER-S..... 72.60 EACH



### "Latch" Tip To Square Driver Adapter

Use Your Latch Type Driver Tip  
With These Salvin Torque Wrenches





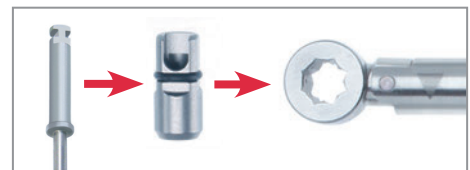







#LATCH-ADAPT..... 46.90 EACH



Square Connection Abutment Driver Tips - Fit Salvin Square Connection Torque Wrenches

Specify Implant Systems When Ordering – We'll Make Sure You Get The Right Driver Tips!

 <p><b>.048" (1.22mm) Hex - 6mm</b> #HNT ..... 57.40 EACH</p> <p><b>.048" (1.22mm) Hex Long - 12mm</b> #HNTL ..... 57.40 EACH</p> <p>For NobelBiocare, 3i, Keystone, MegaGen, Hiossen, Dentium</p>	 <p><b>.05" (1.25mm) Hex - 6mm</b> #HTT ..... 57.40 EACH</p> <p><b>.05" (1.25mm) Hex Long - 12mm</b> #HTLT ..... 57.40 EACH</p> <p>For Zimmer, Astra, BioHorizons, Intra-Lock, MIS, SteriOss, Sybron, Implant Direct, PerioSeal</p>	 <p><b>PROC Driver - 6mm</b> #PROC-S ..... 75.90 EACH</p> <p><b>PROC Driver Long - 12mm</b> #PROC-L ..... 75.90 EACH</p> <p>"Star" Driver For NobelBiocare Active &amp; Unigrip Screw, Neoss</p>
 <p><b>Screw Driver - 6mm</b> #SN ..... 57.40 EACH</p> <p><b>Screw Driver Long - 12mm</b> #SNL ..... 57.40 EACH</p> <p>Flat Blade Screwdriver</p>	 <p><b>.035" (0.9mm) Hex - 6mm</b> #HC ..... 57.40 EACH</p> <p><b>.035" (0.9mm) Hex Long - 12mm</b> #HCL ..... 57.40 EACH</p> <p>For NobelBiocare, 3i, Keystone, BioHorizons, Friadent, PerioSeal</p>	 <p><b>.05" (1.25mm) Square - 6mm</b> #CER-S ..... 57.40 EACH</p> <p><b>.05" (1.25mm) Square Long - 12mm</b> #CER-L ..... 57.40 EACH</p> <p>For 3i</p>
 <p><b>ITI Driver - 6mm</b> #ITIS ..... 75.90 EACH</p> <p><b>ITI Driver Long - 12mm</b> #ITIL ..... 75.90 EACH</p> <p>"ITI" Driver For Straumann SCS</p>	 <p><b>LOC Triangle Driver - 6mm</b> #TRIS ..... 57.40 EACH</p> <p><b>LOC Triangle Driver Long - 12mm</b> #TRIL ..... 57.40 EACH</p> <p>For Locator™ Abutment</p>	 <p><b>.07" (1.77mm) Hex - 6mm</b> #HTSI ..... 57.40 EACH</p> <p>For Paragon TSI Abutment</p>
 <p><b>.08" (2.03mm) Female Hex - 6mm</b> #HFD ..... 57.40 EACH</p> <p>For NobelBiocare, 3i</p>	 <p><b>TG Driver</b> #TG ..... 89.30 EACH</p> <p>For 3i TG Abutment, Straumann SCS</p>	

Abutment Driver Adapters & Handles

Use Torque Wrench For Final Seating



Torque Wrench Adapter For NobelBiocare



#TORQ-ADAP-NOBEL . . . . 88.50 EACH  
Allows Use Of All Salvin Driver Tips On This Page With Your Wrench



Straight Driver Tip Handle

#ISIH ..... 168.30 EACH



Reversible Ratchet

#RATCHET ..... 161.90 EACH

Torque Wrench Adapter For Straumann



#TORQ-ADAP-ITI ..... 88.50 EACH  
Allows Use Of All Salvin Driver Tips On This Page With Your Wrench



Thumb Knob

Convenient For Starting Screws  
#TK ..... 76.90 EACH

Implant & Abutment Names Are Trademarks Of Their Respective Companies

**SalvinTorq®**  
Adjustable Torque Wrench

- ▶ Torque Wrench
- ▶ Adjustable Torque
- ▶ Square Connection



Nine Torque Settings:  
15, 20, 25, 30, 35, 40,  
45, 50 & 60 Ncm

**MOST POPULAR**

**Adjustable Torque Wrench**

#SALVIN-TORQ ..... 605.00 EACH

*Use With Driver Tips On Page 173*



Lubrication Hole  
At 15Ncm Setting

**SPECIAL**

**SalvinTorq® Package**

SalvinTorq® Wrench, Thumb Knob & Cassette  
With Your Choice Of Four Driver Tips

#SALVINTORQ-KIT-4 ..... 876.00 KIT

SalvinTorq® Wrench, Thumb Knob & Cassette  
With Your Choice Of Six Driver Tips

#SALVINTORQ-KIT-6 ..... 918.00 KIT

*Please Specify Implant System & We'll Make Sure That You Have The Correct Driver Tips*



**Salvin Torque Wrenches**

- ▶ Torque Wrench
- ▶ Square Connection



- 20 Newton Centimeters  
#TORQ 20. . . . .228.90 EACH
- 30 Newton Centimeters  
#TORQ 30. . . . .228.90 EACH
- 35 Newton Centimeters  
#TORQ 35. . . . .228.90 EACH

*Use These Wrenches With Driver Tips On Page 174*



- 3rd Molar Retractor . . . . . 123  
 45° Surgical Handpiece . . . . . 62  
 Abutment Holders . . . . . 170  
 AccessTorq® Torque Wrench . . . . . 173  
 Adson Forceps . . . . . 136-137  
 AED . . . . . 22  
 Alveoplasty Burs . . . . . 59  
 Anesthetic Syringes . . . . . 135  
 Aspirators, Surgical . . . . . 146-147  
 Atraulux® Elevators . . . . . 72  
 Atraulux® Extraction Forceps . . . . . 78  
 Atraumatic Extraction . . . . . 66-85  
 Autoclave Tape . . . . . 41  
 Automatic Membrane Tack System . . . . . 13  
 AutoTome® Extraction Kit . . . . . 66  
 AutoTome® Osteotome Kit . . . . . 67  
 AutoTorq® Electric Torque Driver . . . . . 172  
 Balshi Zygomatic Retractor . . . . . 123  
 Bendable Scalpel Blades . . . . . 141  
 Benex Extraction System . . . . . 85  
 BIO-PRF Horizontal Centrifuge . . . . . 9  
 Bleeding Control . . . . . 26-27  
 Blood Collection . . . . . 8-10  
 Blood Pressure Monitors . . . . . 18-21  
 BloodStop® Hemostatic Gauze . . . . . 26  
 Bone Block Clamps . . . . . 94  
 Bone Chip Maker . . . . . 87  
 Bone Chisels . . . . . 103  
 Bone Collector Burs . . . . . 87  
 Bone Curettes, Lucas . . . . . 86  
 Bone Expander Kits . . . . . 106  
 Bone Files . . . . . 134  
 Bone Graft Packers . . . . . 88-89  
 Bone Graft Syringes . . . . . 90-91  
 Bone Mills & Bone Morselizer . . . . . 95  
 Bone Saws . . . . . 52  
 Bone Scrapers . . . . . 92-93  
 Bone Fixation Screws . . . . . 17  
 Bone Spreaders . . . . . 106-109  
 Bone Trap . . . . . 93  
 Bone Wax . . . . . 26  
 Books & Patient Education . . . . . 29, 152-157  
 Bouffant Caps . . . . . 39  
 Broken Screw Remover Kit . . . . . 7  
 Bur Blocks . . . . . 61  
 Burs & Drills . . . . . 54-60  
 Calipers . . . . . 162-163  
 Cannulas, Nasal . . . . . 24  
 Capnography Monitors & Accessories . . . . . 18-21  
 Cassettes, Instrument . . . . . 42  
 Castroviejo Needle Holders . . . . . 126-128  
 Cautery Systems . . . . . 27  
 Cement, Implant . . . . . 167  
 Centrifuges . . . . . 8-9  
 Chair Pads . . . . . 45  
 Cheek Retractors . . . . . 122-125  
 Chisels, Bone . . . . . 103  
 Clamps, Bone Block . . . . . 94  
 Clamps, Suction . . . . . 145  
 CO<sub>2</sub> Monitors . . . . . 20-21  
 CO<sub>2</sub> Nasal Hoods . . . . . 23  
 Cold Packs . . . . . 40  
 Contrasters, Photography . . . . . 165  
 Covers, Light Handle . . . . . 41  
 Covers, Machine & Mayo Stand . . . . . 41  
 Covers, Shoe . . . . . 39  
 Crest-Control, Meisinger . . . . . 109  
 Crestal Sinus Lift Kit . . . . . 96, 99  
 Cricothyrotomy Kit . . . . . 25  
 Criticare Monitors . . . . . 19-20  
 Crown Grippers . . . . . 169  
 Crown Removal Burs . . . . . 59  
 Crown Removers . . . . . 168  
 Curettes, Perio . . . . . 124  
 Curettes, Titanium . . . . . 171  
 Cyanoacrylate . . . . . 28  
 CytoSurg® PTFE Sutures . . . . . 30  
 Defibrillators . . . . . 22  
 Degranulation Burs . . . . . 59  
 Depth Gauges . . . . . 162  
 Diagnostic Instruments . . . . . 11, 159-166  
 Distortion Markers, X-Ray . . . . . 160  
 Drapes, Patient . . . . . 34-37  
 Drill Driver Kit . . . . . 106  
 Drill Extender . . . . . 55  
 Drill Guides . . . . . 164  
 Drill Stops . . . . . 54  
 Drills & Burs . . . . . 54-60  
 Driver Tips . . . . . 173-174  
 EasyReach® Prosthetic Wrench . . . . . 172  
 ECG Monitors . . . . . 20-21  
 ECG Patches & Wrist Clips . . . . . 23  
 Electric Torque Driver . . . . . 172  
 Electrocautery . . . . . 27  
 Elevators . . . . . 68-77  
 Elevators, PDL . . . . . 68  
 Elevators, Periosteal . . . . . 118-120  
 Elevators, Third Molar . . . . . 123  
 Emergency Equipment . . . . . 22-25  
 Enlighten® LED System . . . . . 153  
 External Irrigation . . . . . 148-149  
 Extraction Forceps . . . . . 78-83  
 Extraction, Atraumatic . . . . . 68-85  
 Featherlite Scissors . . . . . 28, 132  
 Fiber Optic Headlamps . . . . . 153  
 Files, Bone . . . . . 134  
 Files, Periodontal . . . . . 133  
 Fixation Screws . . . . . 17  
 Flap Holding Forcep . . . . . 94  
 Forceps, Membrane . . . . . 14-15  
 Forceps, Extraction . . . . . 78-83  
 Forceps, Root Tip . . . . . 80, 84  
 Forceps, Suture . . . . . 139  
 Forceps, Tissue . . . . . 136-139  
 Fragment Forceps . . . . . 84  
 Furniture, O/R . . . . . 150-152  
 Gloves, Sterile . . . . . 44-45  
 Gowns, Sterile & Non-Sterile . . . . . 38  
 Graft Mixing Dishes . . . . . 91  
 Graft Packers . . . . . 88-89  
 Graft Syringes . . . . . 90-91  
 Guide Pins . . . . . 164  
 Handpiece Lubricant . . . . . 53, 62  
 Handpiece, Third Molar . . . . . 62  
 Handpieces, Implant . . . . . 50  
 Hand Scrubs . . . . . 40  
 Headlamp . . . . . 153  
 HemCon® Dental DressingPro . . . . . 27  
 Hemostatic Sponges & Gauze . . . . . 26-27  
 Hemostats . . . . . 26  
 High Speed Handpieces . . . . . 62  
 Horizontal Centrifuge . . . . . 9  
 Hygiene, Implant . . . . . 63, 170-174  
 Ice Packs . . . . . 40  
 Impl-Safe Peri-Implant Management Set . . . . . 64  
 Implant Abutment Holders . . . . . 170  
 Implant Brush, Titanium . . . . . 63  
 Implant Center Piezo + Motor . . . . . 47  
 Implant Detector, Spotter . . . . . 160  
 Implant Equipment Cart . . . . . 150  
 Implant Cement . . . . . 167  
 Implant Drill Stops . . . . . 54  
 Implant Drills . . . . . 54-55  
 Implant Hygiene . . . . . 63, 170-171  
 Implant Positioning Guides . . . . . 164  
 Implant Models . . . . . 154-157  
 Implant Motor Stands . . . . . 152  
 Implant Motors & Handpieces . . . . . 50-51  
 Implant Packs . . . . . 34-37  
 Implant Removal Kit . . . . . 7  
 Implant Rescue Kit . . . . . 7  
 Implant Scalars . . . . . 170-171  
 Implant Stability, Penguin . . . . . 11  
 Improv Implant Cement . . . . . 167  
 Infection Control . . . . . 34-35  
 Instrument Cassettes . . . . . 42  
 Instrument Cleaner . . . . . 41  
 Irrigation Needles & Syringes . . . . . 149  
 Irrigation Tubing . . . . . 53, 148  
 Irrigation, External . . . . . 148-149  
 Irrigation Syringes . . . . . 149  
 Isolation Gowns . . . . . 38  
 IV Stand . . . . . 152  
 Kerrison Rongeur . . . . . 100, 105  
 Knives, Perio . . . . . 133  
 Laryngeal Tubes . . . . . 24  
 Laster 3rd Molar Retractor . . . . . 123  
 LED Headlight . . . . . 153  
 Light Handle Covers . . . . . 41  
 Lindemann Burs . . . . . 56  
 Locator Implant Models . . . . . 157  
 Lucas Bone Curettes . . . . . 86  
 Luxating Elevators . . . . . 68-75  
 Machine Covers . . . . . 41  
 Mallet, Mead . . . . . 103  
 Mandibles, Drilling . . . . . 159  
 Marking Pens, Sterile . . . . . 160  
 Masks, N95 . . . . . 39  
 Masks, Surgical . . . . . 39  
 Master Core Kit . . . . . 87  
 Mayo Stand Covers . . . . . 41  
 Mayo Stands . . . . . 152  
 Mead Mallet . . . . . 103  
 Meisinger Bone Master Core Kit . . . . . 87  
 Meisinger Pin Control . . . . . 13  
 Membrane Forceps . . . . . 14-15  
 Membrane Tacks . . . . . 12-13  
 Mesh, Titanium . . . . . 15  
 Micro Needle Holders . . . . . 5, 116, 127  
 Micro Scalpel Blades . . . . . 141  
 Micro Scissors . . . . . 117  
 Micro Surgery . . . . . 4-5, 110-117  
 Mindray Vital Sign Monitors . . . . . 19, 21  
 Minnesota Retractor . . . . . 124  
 Mirror Handles . . . . . 161  
 Mirrors . . . . . 161, 165-166  
 Models, Implant . . . . . 154-157  
 Molt Mouth Gag . . . . . 122  
 Monitors, Vital Sign . . . . . 18-21  
 Motors, Implant . . . . . 51  
 Motor Stands . . . . . 152  
 Mouth Props . . . . . 125  
 N95 Respirator Masks . . . . . 39  
 NaCl Sterile Saline . . . . . 149  
 Narrow Implant Broken Screw Kit . . . . . 7  
 Nasal Cannula . . . . . 24  
 Nasal Hoods, CO<sub>2</sub> . . . . . 23



Nasopharyngeal Airways . . . . .	24	Root Tip Forceps . . . . .	80, 84	Syringes, Irrigation . . . . .	149
Needle Holders . . . . .	126-129	Rotary Tissue Punches . . . . .	142	Table Covers . . . . .	41, 152
Needles, Irrigation . . . . .	149	RotoBrush-Titanium™ . . . . .	63	Tables, Surgical . . . . .	151
Neumeyer Root Planing Bur . . . . .	57	Rulers, Surgical . . . . .	160	Tacks, Membrane . . . . .	12-13
No-Clog Aspirators . . . . .	147	Safe Relax Crown & Bridge Remover . . . . .	168	Tenting Screws . . . . .	16
Non-Glare Microsurgery Kit . . . . .	4-5	Sagittal Bone Saw . . . . .	52	Third Molar Elevators . . . . .	69
Nordland Micro Blade . . . . .	141	Saline, Sterile . . . . .	149	Third Molar Handpiece . . . . .	62
O/R Gowns . . . . .	38	SalvinMesh-Ti™ Titanium Mesh . . . . .	15	Third Molar Retractor . . . . .	123
O/R Towels . . . . .	38-39	Saw Discs . . . . .	55	Tissue Forceps . . . . .	136-139
OraFoam™ Hemostatic Sponges . . . . .	26	Saws, Bone . . . . .	52	Tissue Forceps, Micro . . . . .	5, 112
Orban Knife . . . . .	133	Scalers, Implant . . . . .	170-171	Tissue Marking Pens . . . . .	160
Oscillating Bone Saw . . . . .	52	Scalpel Blades & Handles . . . . .	140-141	Tissue Punches . . . . .	142-143
OsseoScrape™ Bone Scraper . . . . .	92	Scissors, Micro . . . . .	117	Tissue Rakes . . . . .	94
Osseous Trap . . . . .	93	Scissors, Supercut . . . . .	131	Tissue Scissors . . . . .	130-132
Osteotomes, Bone Spreading . . . . .	67, 106-109	Scissors, Suture . . . . .	28, 130-132	Titanium Implant Brush . . . . .	63
Osteotomes, Sinus . . . . .	97-98	Scissors, Tissue . . . . .	130-132	Titanium Mesh . . . . .	15
Packs, Sterile . . . . .	34-37	Scoring Bur, Sinus . . . . .	57	Tongue Retractor . . . . .	123
Paralleling Guides . . . . .	164	Screws, Fixation . . . . .	16	Torque Wrenches . . . . .	172-173, 175
Parts Cassettes . . . . .	43	Scrub Brushes . . . . .	40	Towel Clamps . . . . .	38
Patient Drapes . . . . .	34-37	Scrub Towels . . . . .	38	Towels, O/R . . . . .	38-39
Patient Education . . . . .	154-159	Sectioning Bur . . . . .	57	Trephines . . . . .	60
PDL-Evators® . . . . .	68	Sedation Monitors . . . . .	18-21	Tubing Covers . . . . .	37
P.E.T Partial Extraction Therapy Burs . . . . .	58	Serrated Elevators . . . . .	73	Tubing, Handpiece Irrigation . . . . .	53, 148
Penguin RFA Implant Stability Analysis . . . . .	11	Serrated Periostomes . . . . .	70-71	Tubing, Suction . . . . .	144-145
Peri-Implant Management Set . . . . .	64	Shoe Covers . . . . .	39	Tunneling Forceps . . . . .	116
Peri-Implantitis Brushes & Burs . . . . .	63	Side Cutting Needle Holder . . . . .	126	Tunneling Instruments . . . . .	110-116
Periacryl . . . . .	28	Silverstein Suture Book . . . . .	29	Twist Elevators . . . . .	76
Perio Curettes . . . . .	134	Sinus Crestal Kit . . . . .	96	Ultrasonic Surgery, Piezotome . . . . .	46-49
Perio Knives . . . . .	133	Sinus Lateral Burs . . . . .	96	Urban Master Core Kit . . . . .	87
Perio Probes, Plastic & Stainless . . . . .	161	Sinus Lift Instruments . . . . .	96-102	Vacutainer® . . . . .	10
Periodontal Surgical Files . . . . .	133	Sinus Osteotomes . . . . .	97-98	Vital Sign Monitors . . . . .	18-21
Periosteal Elevators . . . . .	118-120	Sinus Rongeur . . . . .	100, 105	Water, Sterile . . . . .	149
Periostomes . . . . .	68-71	Sinus Scoring Diamond . . . . .	57	"Where Is It?" Parts Cassettes . . . . .	43
Photography Contrasters . . . . .	165	Skull Models . . . . .	158	Wire Cutter . . . . .	15
Photography Mirror Handle . . . . .	165	Socket Caliper . . . . .	163	Wrenches, Torque . . . . .	172-173, 175
Photography Mirrors . . . . .	165-166	Soft Tissue Manipulation Kit . . . . .	115	Wrist Clips, ECG . . . . .	23
Physics Forceps . . . . .	83	Solution Bowl . . . . .	148	X-Ray Distortion Markers . . . . .	160
Piezotome Ultrasonic Surgery . . . . .	46-49	Split-Control, Meisinger . . . . .	109	Yankauer Suction . . . . .	25, 144
Pikos Burs . . . . .	56-57	Sponges, Collagen . . . . .	26	ZAGA Zygomatic Instrument Kit . . . . .	6
Pikos Ramus Retractor . . . . .	123	Spotter Smart Implant Detector . . . . .	160	Zoe Vital Sign Monitor . . . . .	20
Pilot Drills . . . . .	55	Stands, Implant Motor . . . . .	152	Zygomatic Instruments . . . . .	6, 123
Pin-Control, Meisinger . . . . .	13	Stands, Mayo . . . . .	152		
Pneumatic Crown Remover . . . . .	168	Sterile Packs . . . . .	34-37		
Pocket Packers . . . . .	89	Sterile Saline & Water . . . . .	149		
PowerTack™ Automatic Tack System . . . . .	13	Sterilization Cassettes . . . . .	42		
Precordial Stethoscope . . . . .	22	Sterilization Wrap & Pouches . . . . .	41-42		
Prep Cup . . . . .	148	Sterillium Rub Surgical Hand Scrub . . . . .	40		
PRF Box . . . . .	8	Stethoscope, Precordial . . . . .	22		
Probes, Plastic & Stainless . . . . .	161	Suction Cut-Off Valves . . . . .	145		
Prosthetic Wrench, Right Angle . . . . .	172-173	Suction Irrigator . . . . .	148		
Prosthetic Parts Drivers . . . . .	172-174	Suction Tips . . . . .	148-149		
PTFE Sutures . . . . .	30	Suction Tubing . . . . .	144-145		
Pulse Oximeters . . . . .	19-21	Suction, Emergency . . . . .	25		
Punches, Tissue . . . . .	142-143	Supercut Scissors . . . . .	131		
Radiographic Marking Balls . . . . .	160	Surgeon's Caps . . . . .	39		
Ramus Retractors . . . . .	123	Surgical Aspirators . . . . .	148-149		
Rapid Roll® Covers . . . . .	37	Surgical Gloves . . . . .	44-45		
Reciprocating Bone Saw . . . . .	52	Surgical Guide Osteotomes . . . . .	98		
Rescue Kit, Implants & Broken Screws . . . . .	7	Surgical Handpieces . . . . .	50, 62		
Resnik Implant Pack . . . . .	36	Surgical Motors . . . . .	51		
Resonance Frequency Analysis (RFA) . . . . .	11	Surgical Rulers . . . . .	160		
Respirator Masks, N95 . . . . .	39	Surgical Tables . . . . .	151		
Retractors, Surgical . . . . .	121-125	Sussman Implant Positioning Guides . . . . .	164		
Ridge Contouring Bur . . . . .	57	Suture Book . . . . .	29		
Ridge Mapping Caliper . . . . .	163	Suture Forceps & Pliers . . . . .	139		
Right Angle Prosthetic Wrench . . . . .	172-173	Suture Scissors . . . . .	28, 130-132		
Ridge Splitting Instruments . . . . .	106-109	Sutures . . . . .	29-33		
Rongeurs . . . . .	104-105	Syringes, Anesthetic . . . . .	135		
Root Planing Bur, Neumeyer . . . . .	57	Syringes, Bone Grafting . . . . .	90-91		



Toll Free 800.535.6566  
[www.salvin.com](http://www.salvin.com)

CHANGE SERVICE REQUESTED

**Salvin Dental Specialties, Inc.**  
3450 Latrobe Drive  
Charlotte, NC 28211 U.S.A.

PRSR STD  
U.S. POSTAGE  
PAID  
PPCO

**Whether You Are New To Implant Dentistry Or Performing  
Advanced Procedures, We've Got The Solutions You Need To  
Make Your Life Easier And Your Practice More Productive.**



**Everything For Your Implant Practice  
But The Implants®**